

Noise spectrum referring to max efficiency of 20° curve
 Variation of +/- 3 db(A) on total range of performance

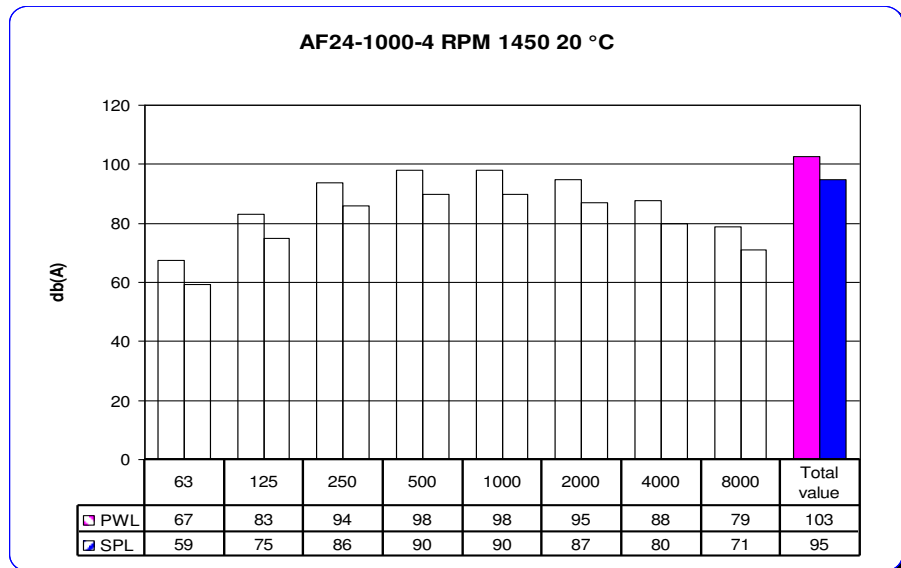

Noise spectrum referring to max efficiency of 20° curve
 Variation of +/- 3 db(A) on total range of performance

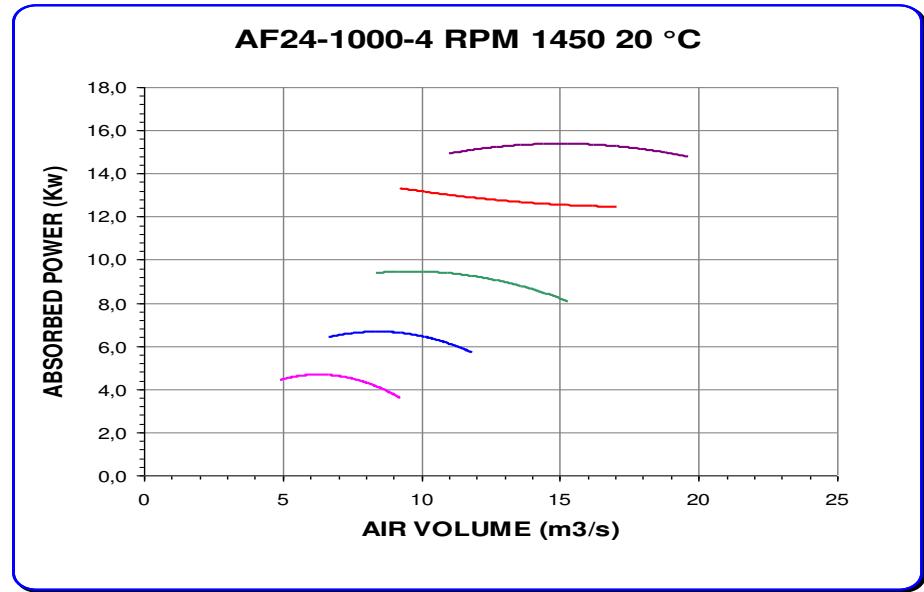
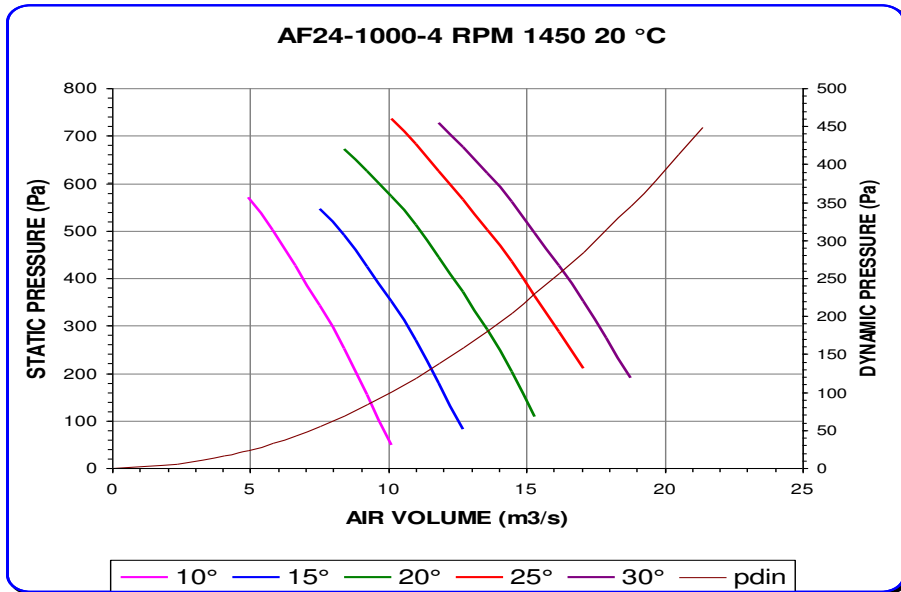
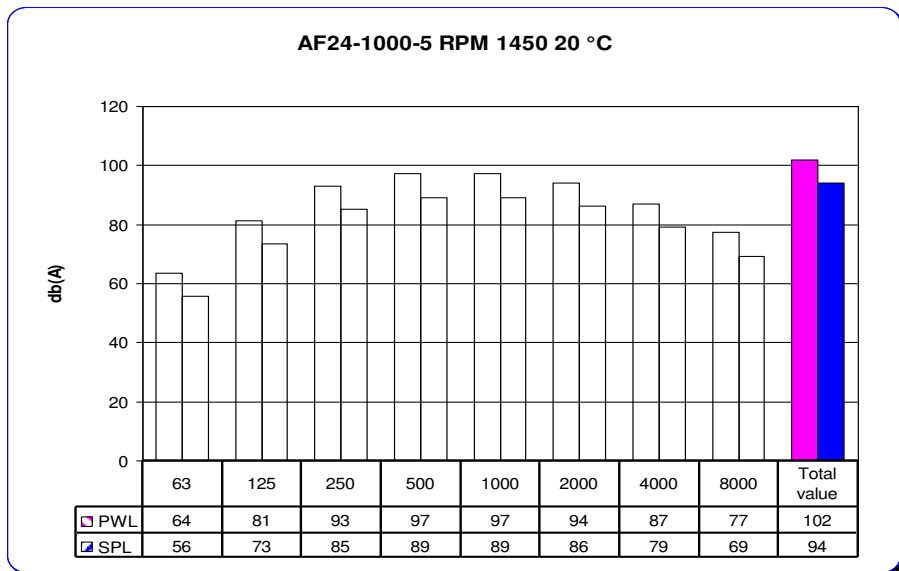
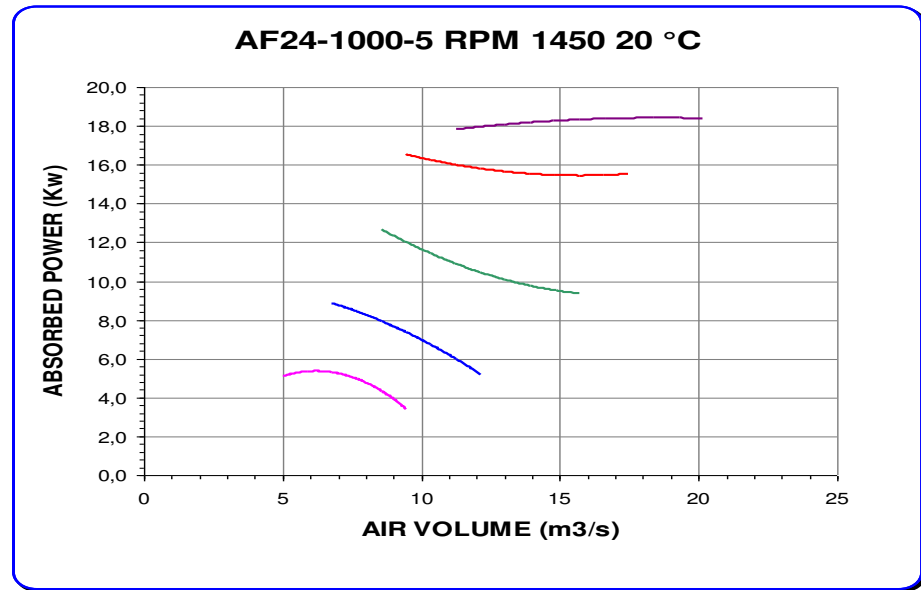
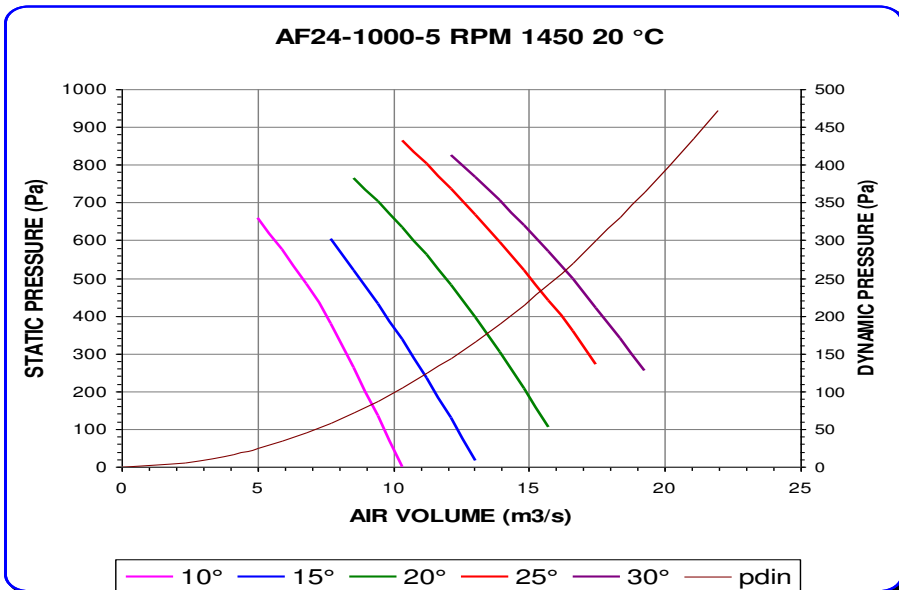

Noise spectrum referring to max efficiency of 20° curve
 Variation of +/- 3 db(A) on total range of performance

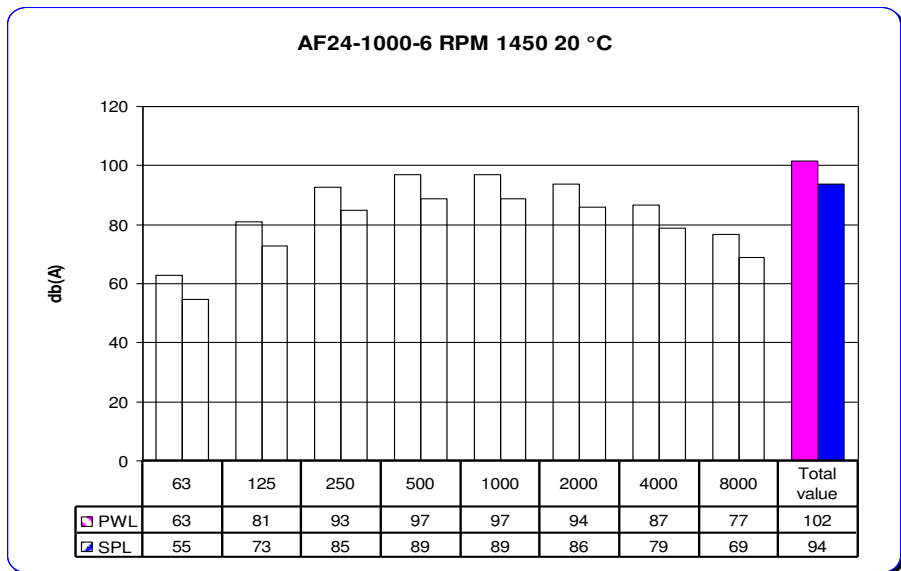
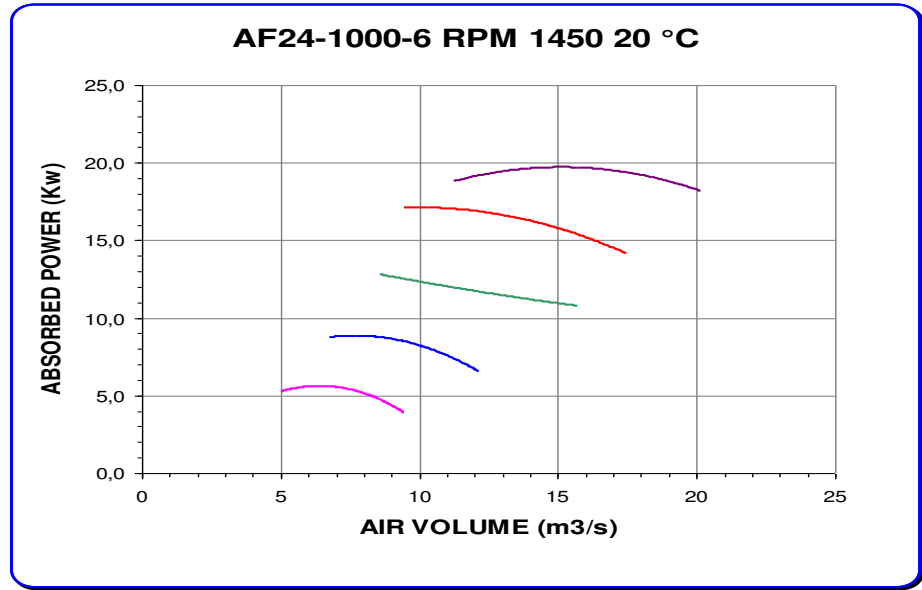
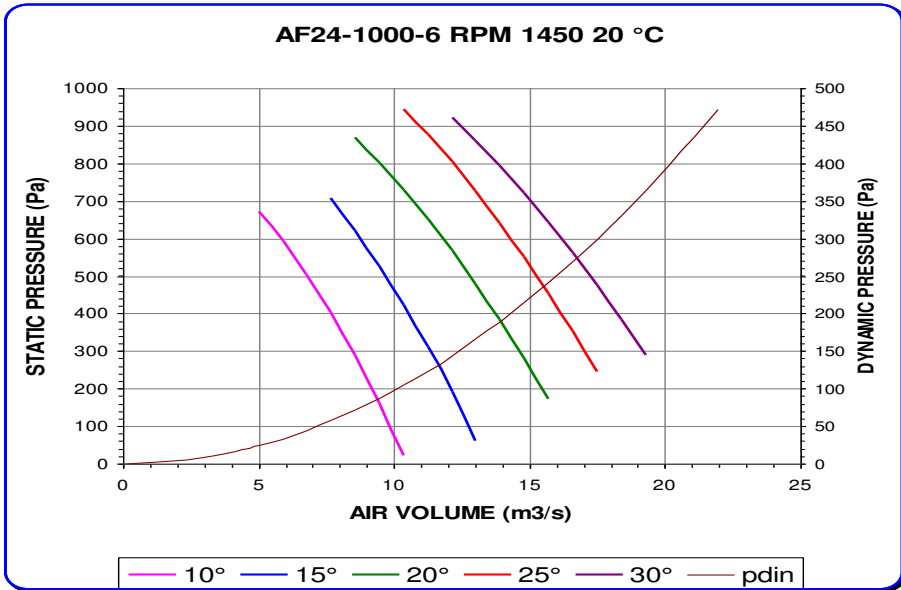

Noise spectrum referring to max efficiency of 20° curve
 Variation of +/- 3 db(A) on total range of performance

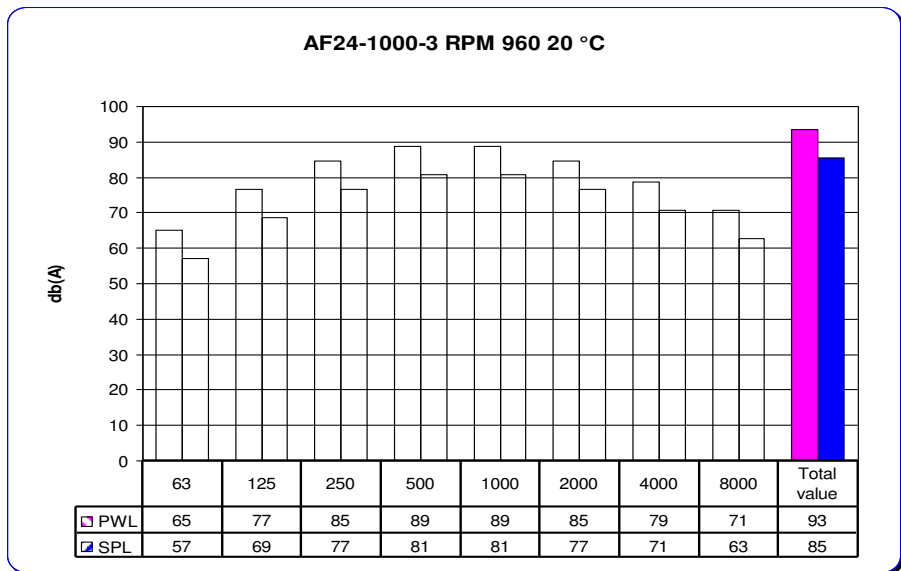
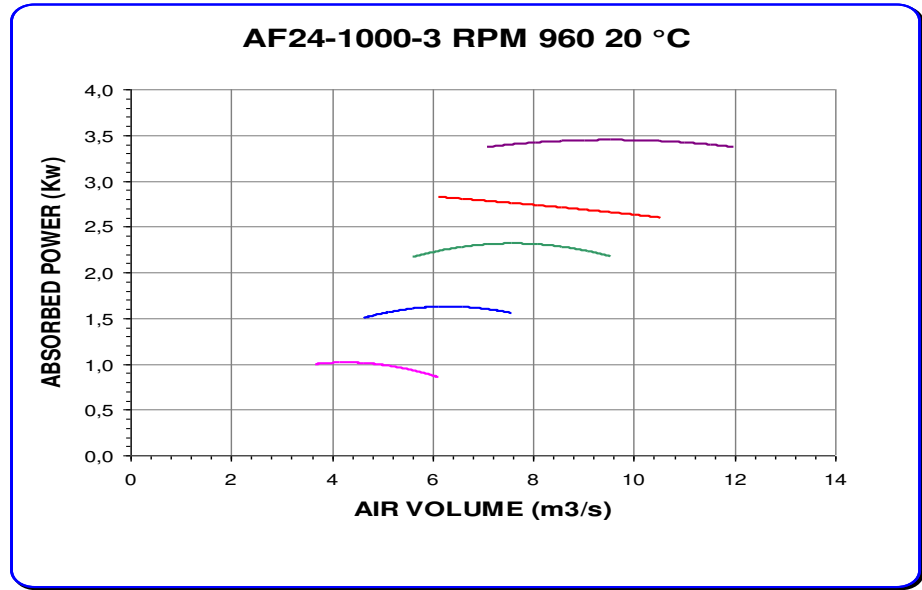
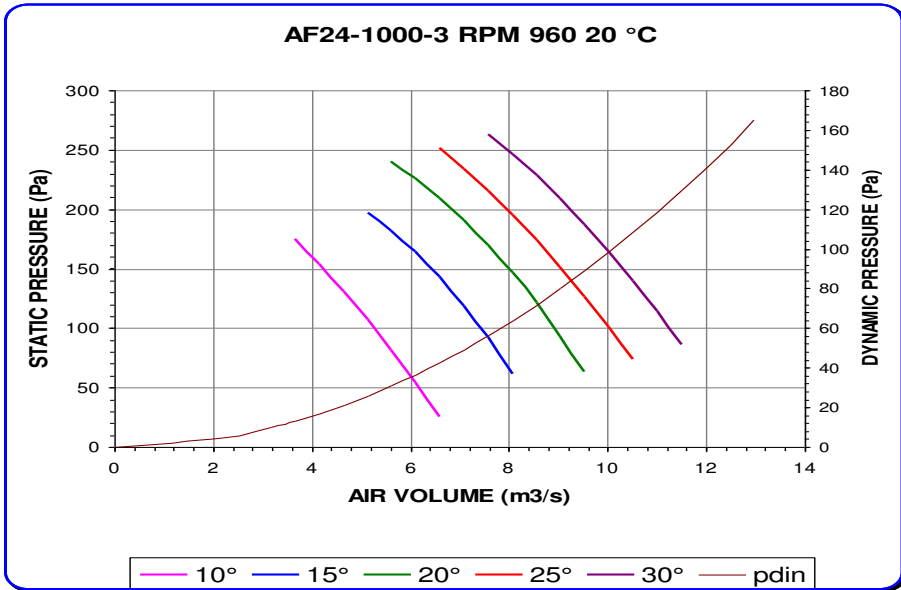

Noise spectrum referring to max efficiency of 20° curve
 Variation of +/- 3 db(A) on total range of performance

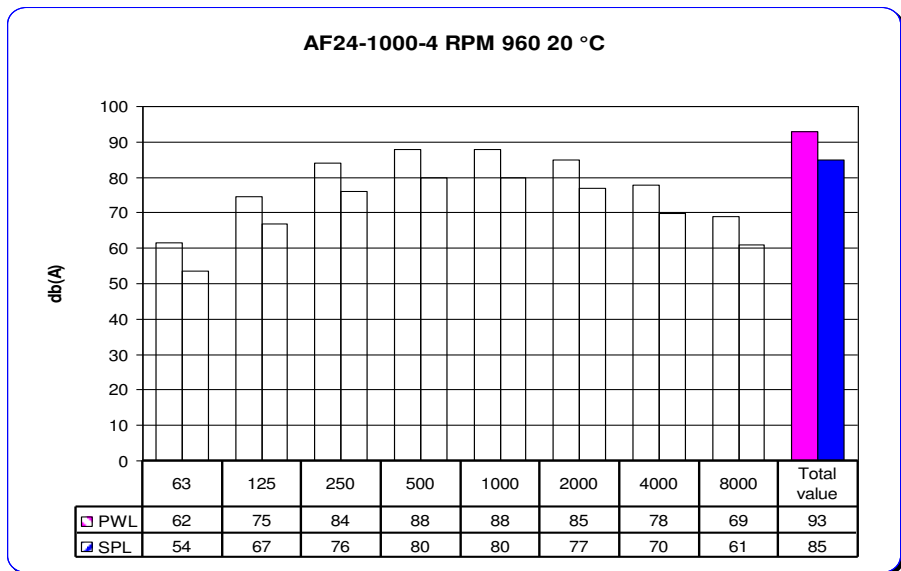
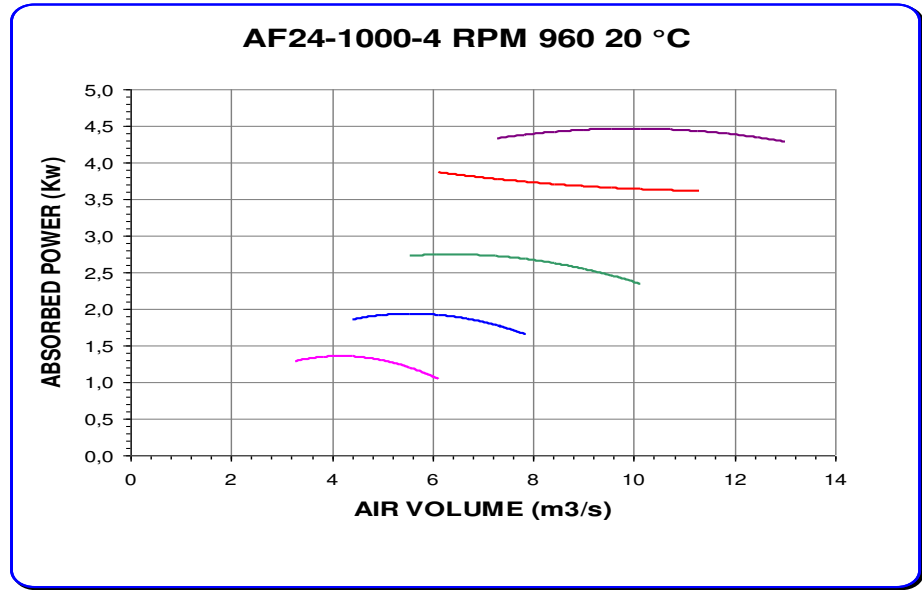
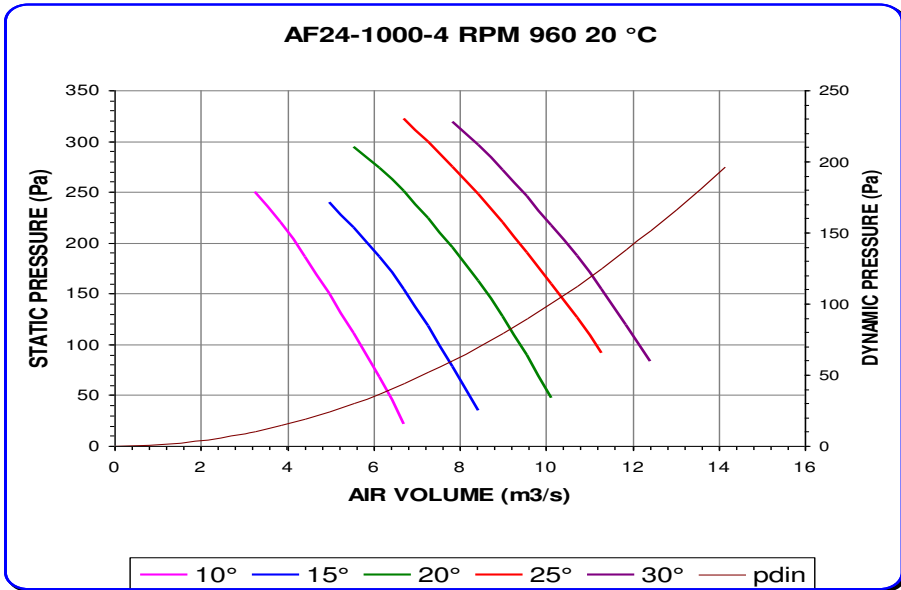

Noise spectrum referring to max efficiency of 20° curve
 Variation of +/- 3 db(A) on total range of performance

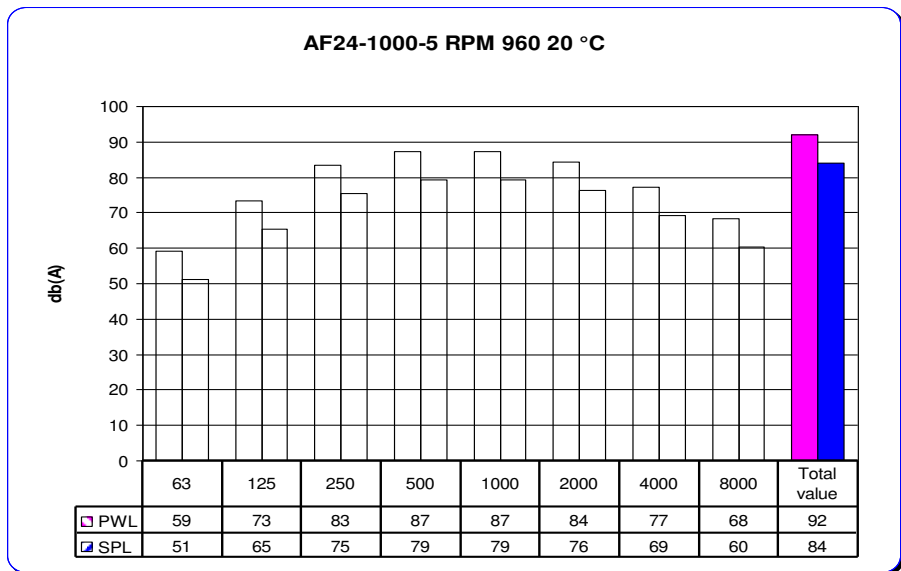
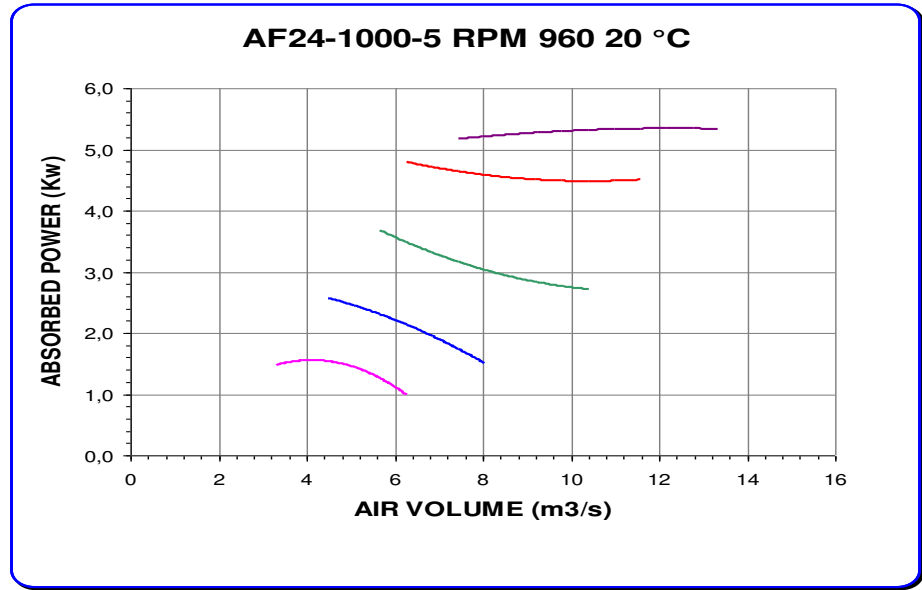
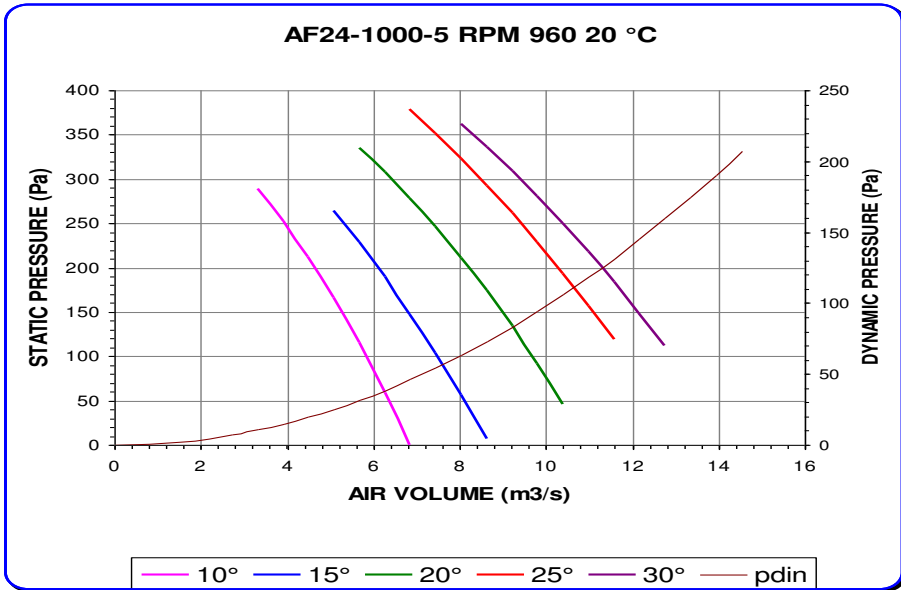

Noise spectrum referring to max efficiency of 20° curve
 Variation of +/- 3 db(A) on total range of performance

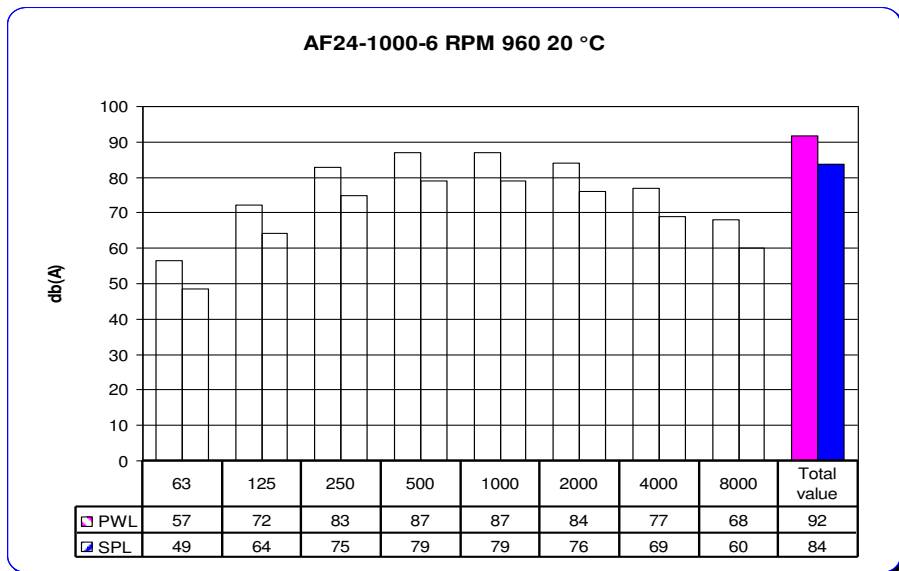
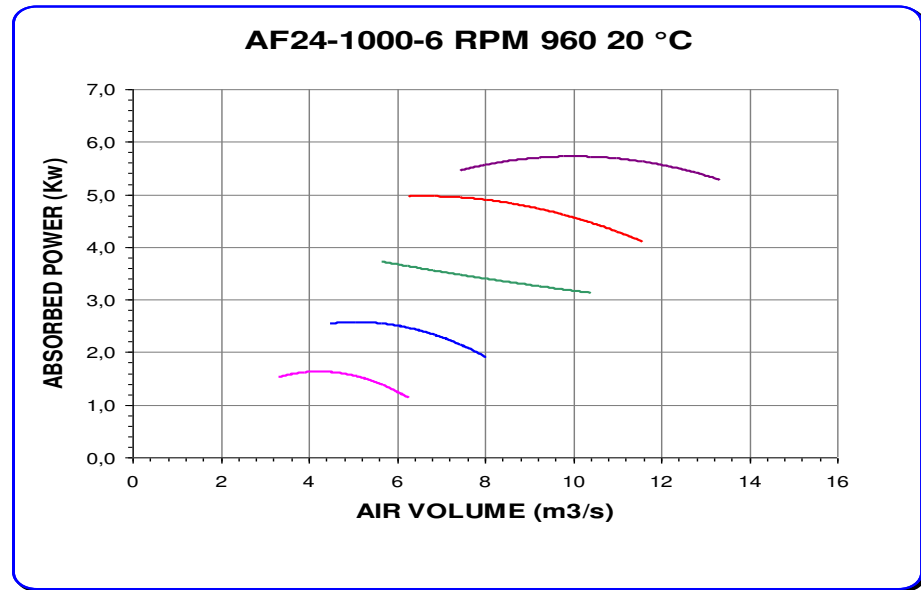
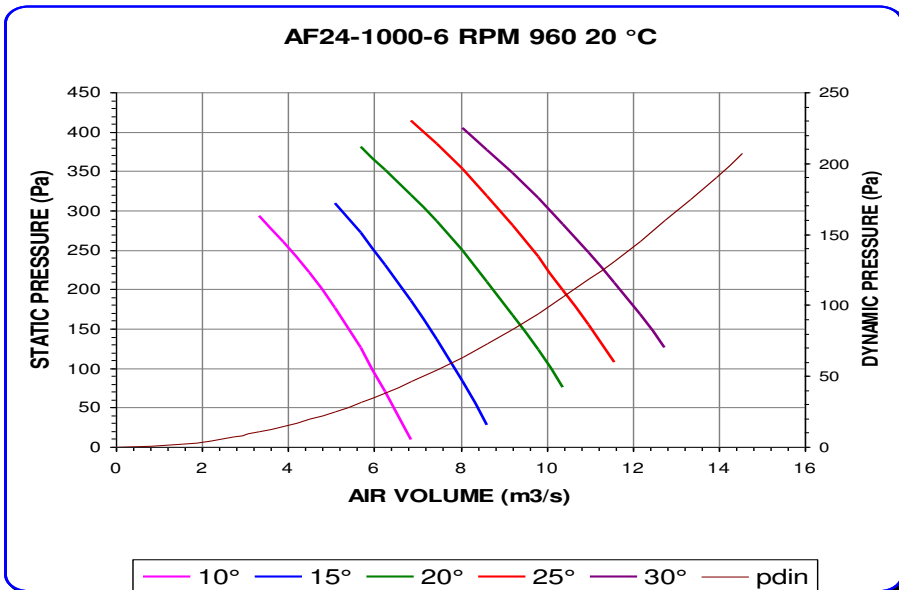

Noise spectrum referring to max efficiency of 20° curve
 Variation of +/- 3 db(A) on total range of performance

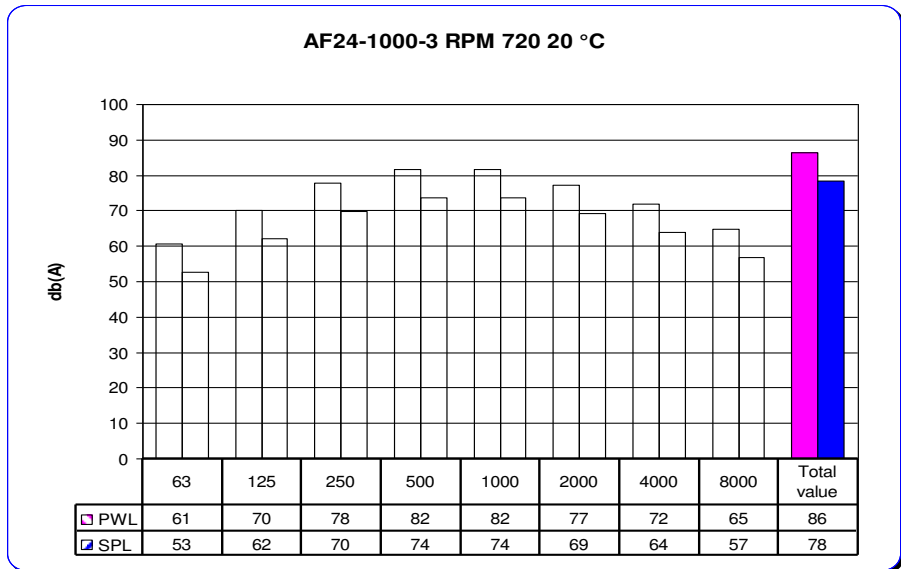
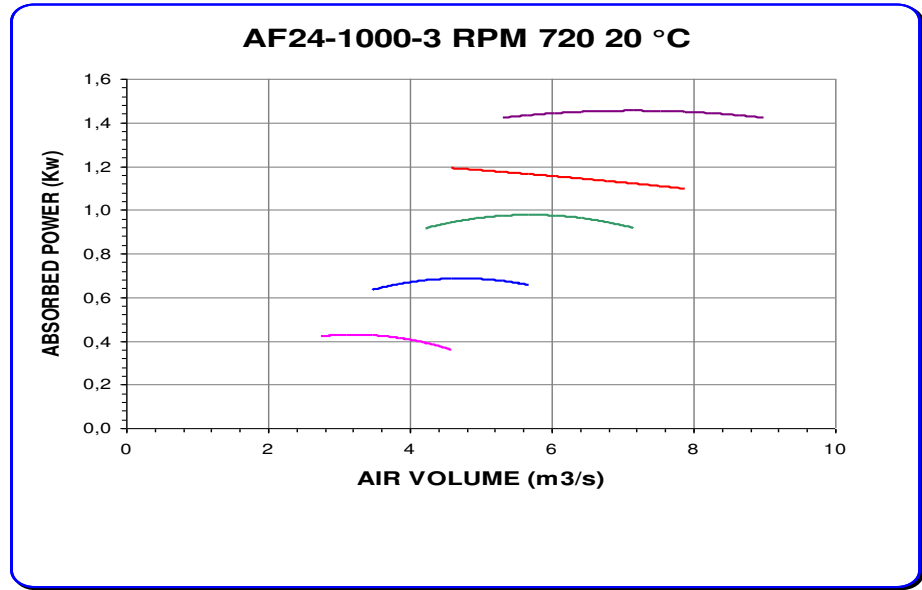
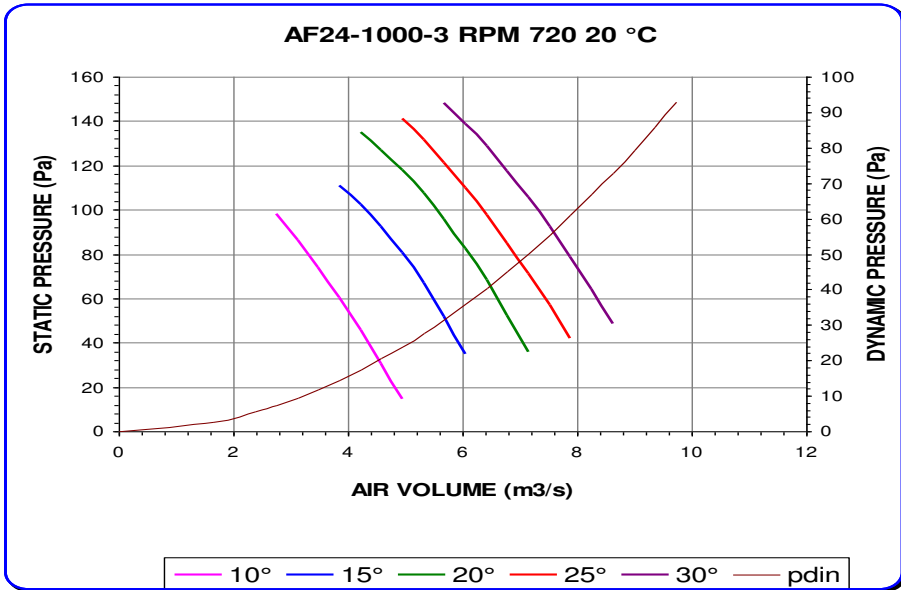

Noise spectrum referring to max efficiency of 20° curve
 Variation of +/- 3 db(A) on total range of performance

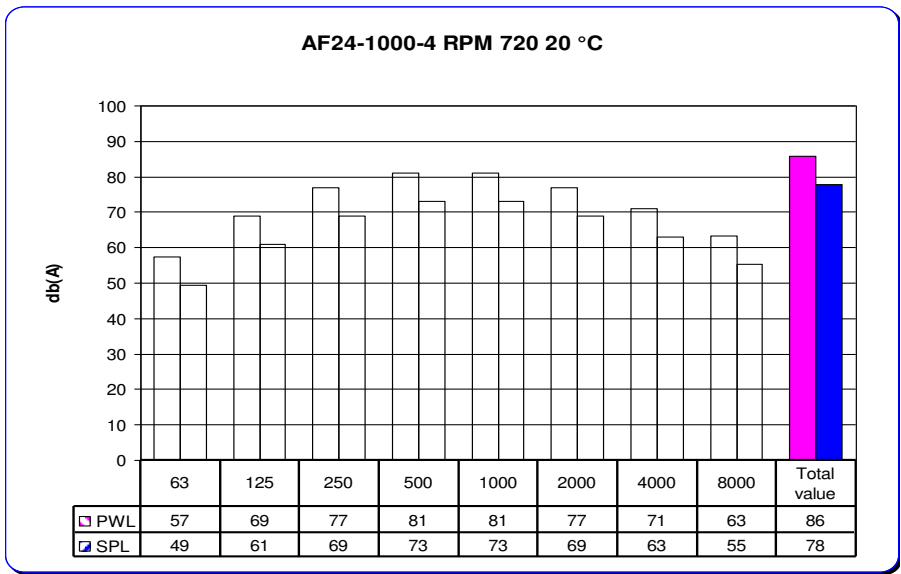
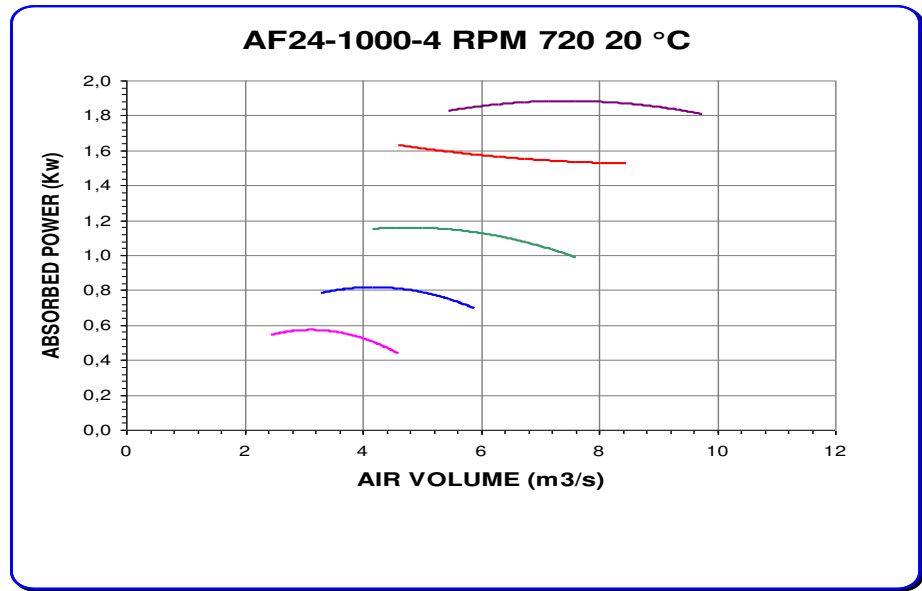
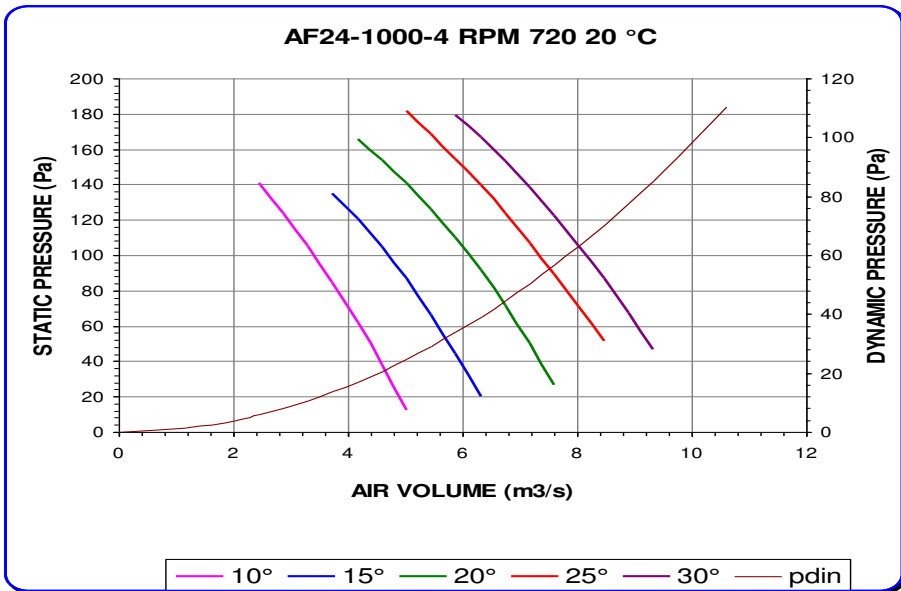

Noise spectrum referring to max efficiency of 20° curve
 Variation of +/- 3 db(A) on total range of performance

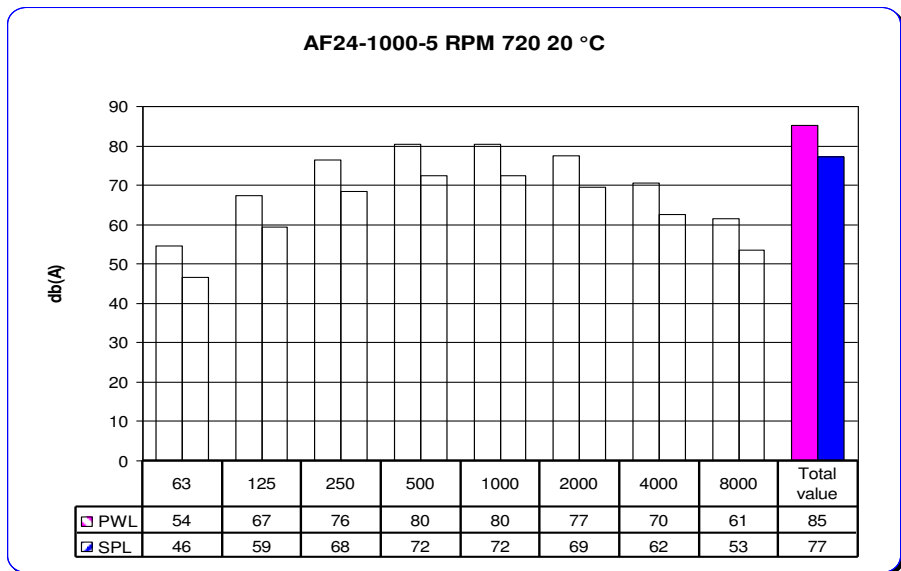
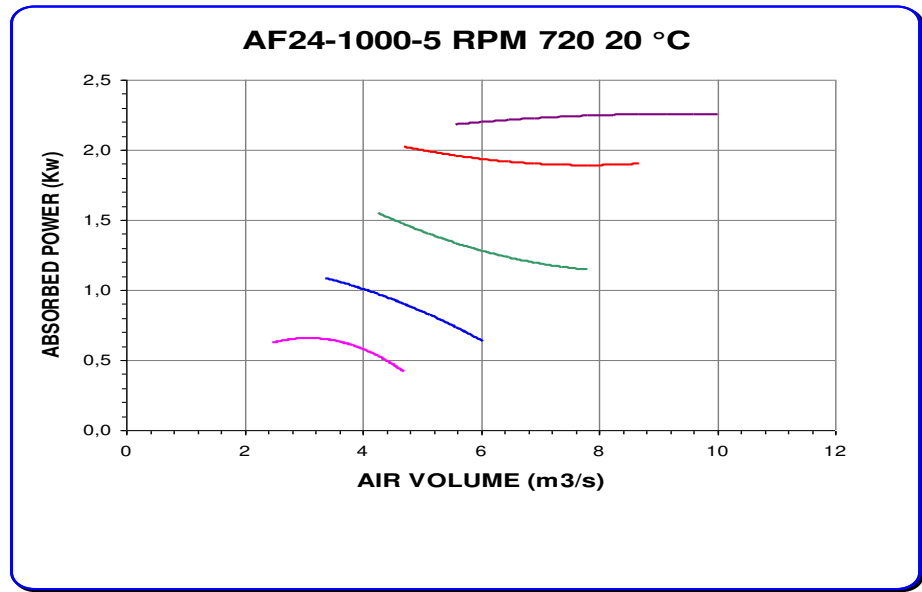
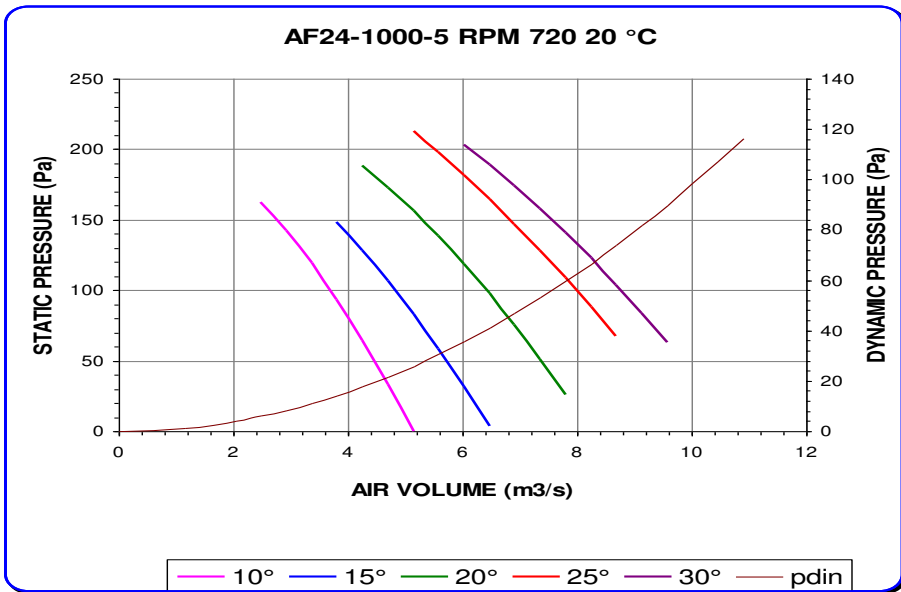

Noise spectrum referring to max efficiency of 20° curve
 Variation of +/- 3 db(A) on total range of performance

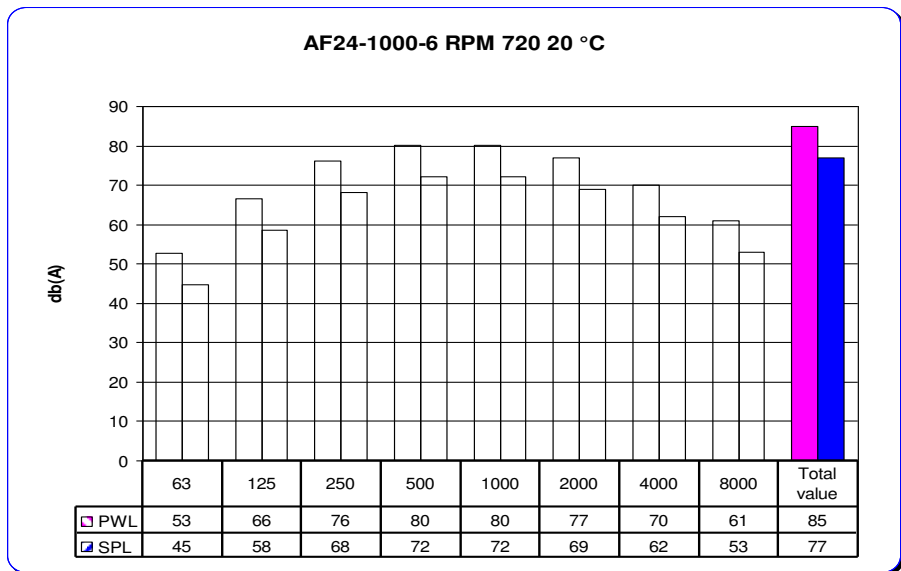
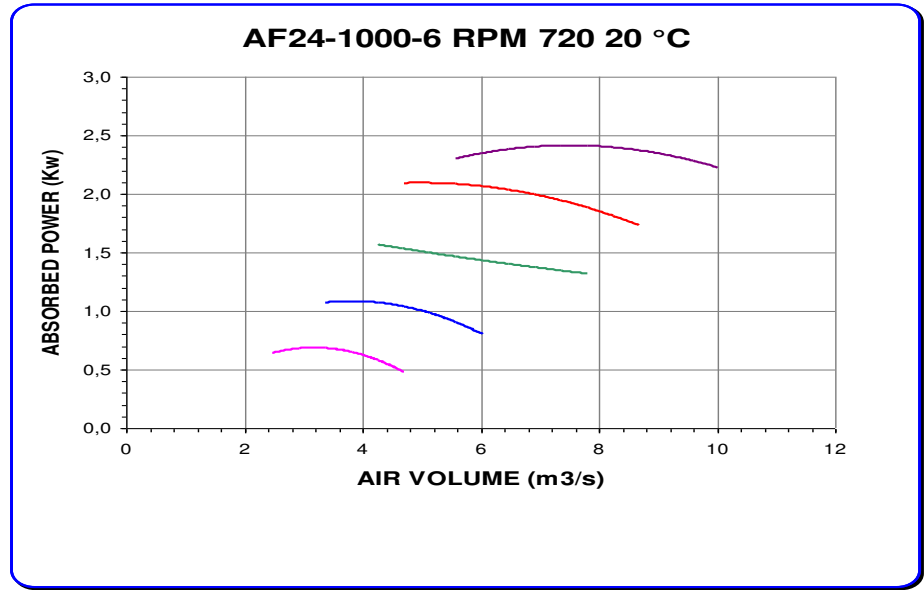
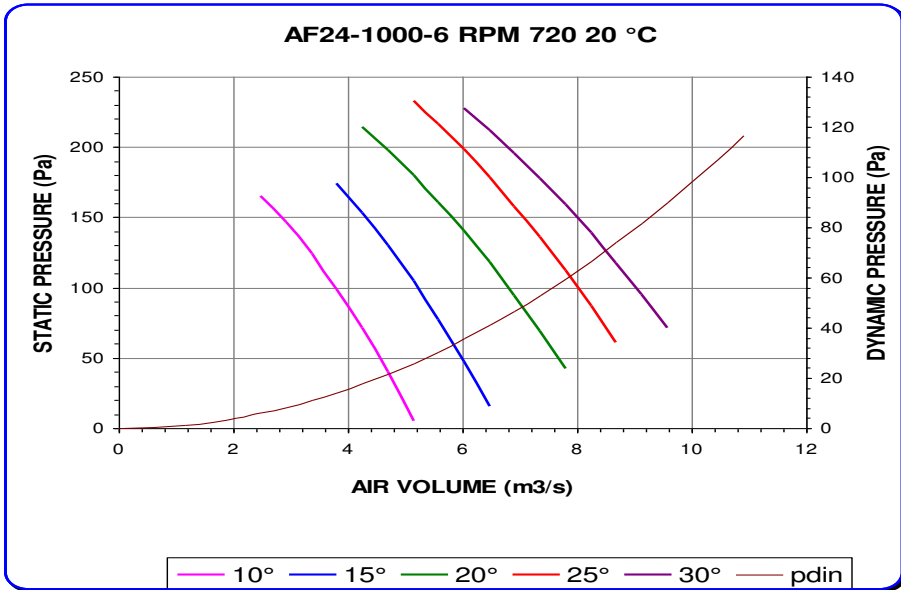

Noise spectrum referring to max efficiency of 20° curve
 Variation of +/- 3 db(A) on total range of performance

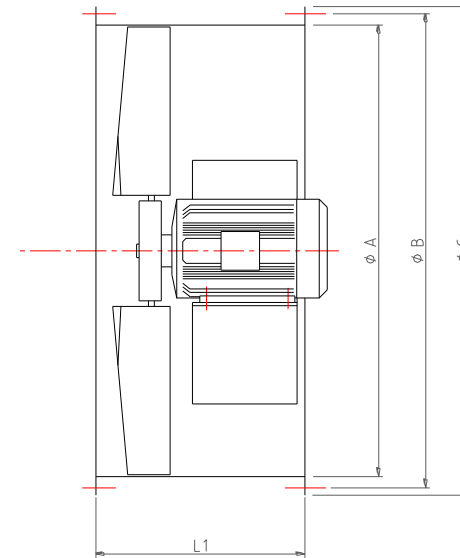
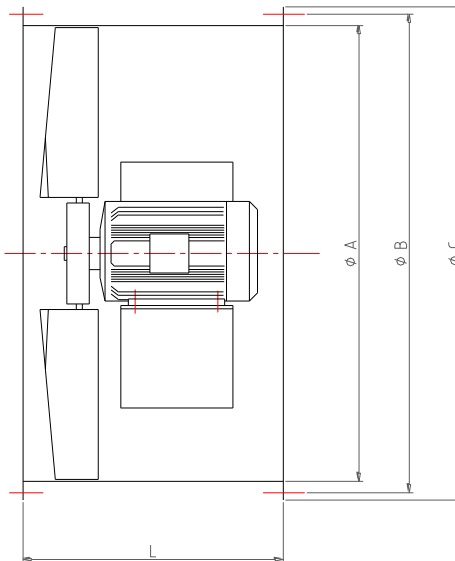
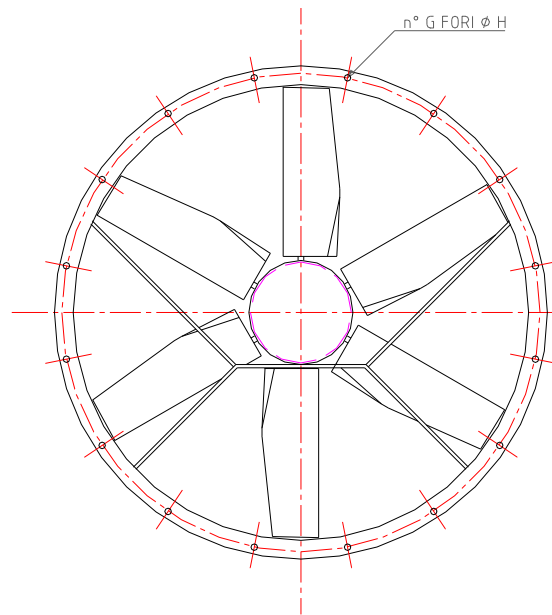

Φ 1000

| Grandezza Motore | A | B | C | L | L1 | G | H | Peso medio con cassa L Kg. | Peso medio con cassa S Kg. |
|------------------|------|------|------|-----|-----|----|----|----------------------------|----------------------------|
| 90 | | | | | | | | 125 | 91 |
| 100 | 1000 | 1070 | 1105 | 500 | 350 | 16 | 15 | 135 | 101 |
| 112 | | | | | | | | 143 | 109 |
| 132 | 1000 | 1070 | 1105 | 600 | 450 | 16 | 15 | 164 | 148 |
| 160 | | | | | | | | 275 | 240 |
| 180 | 1000 | 1070 | 1105 | 800 | 600 | 16 | 15 | 332 | 297 |