

Noise spectrum referring to max efficiency of 20° curve  
 Variation of +/- 3 db(A) on total range of performance

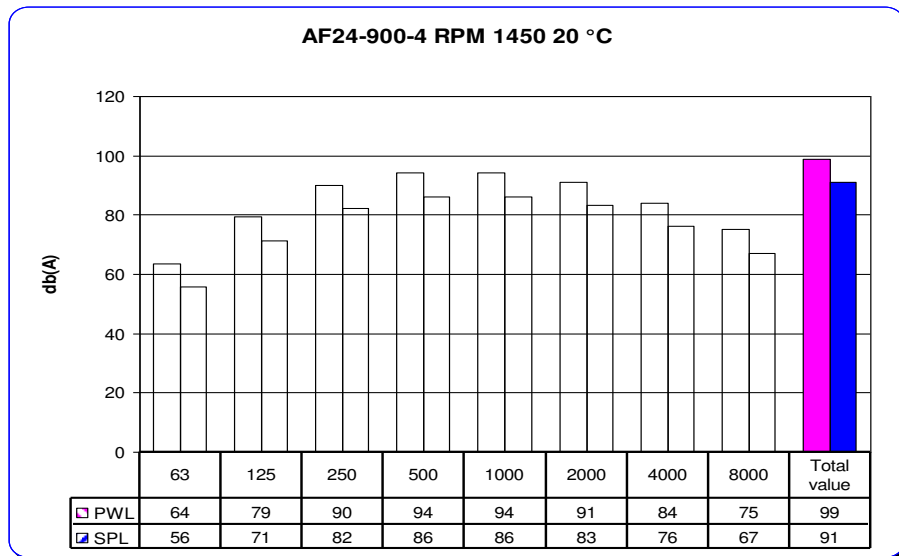

Noise spectrum referring to max efficiency of 20° curve  
 Variation of +/- 3 db(A) on total range of performance

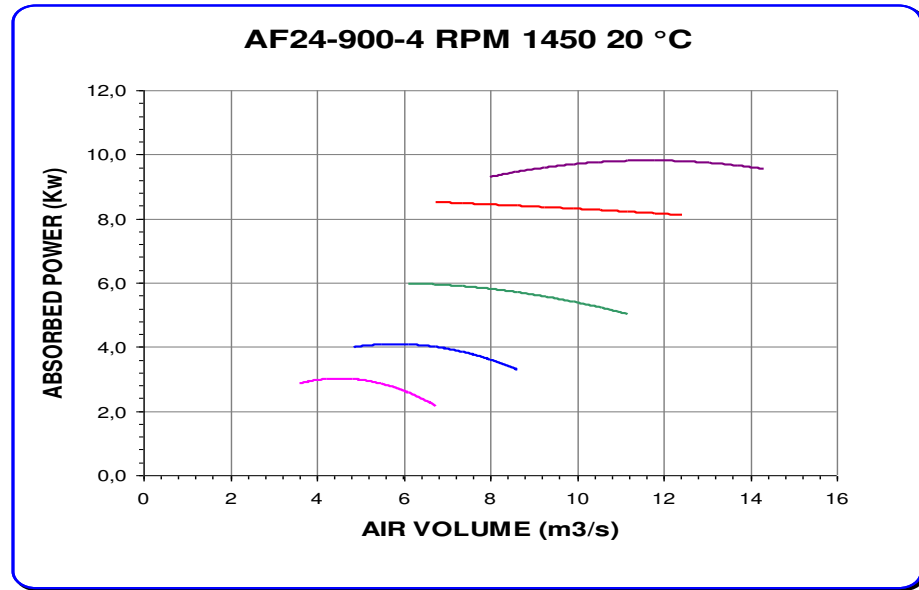
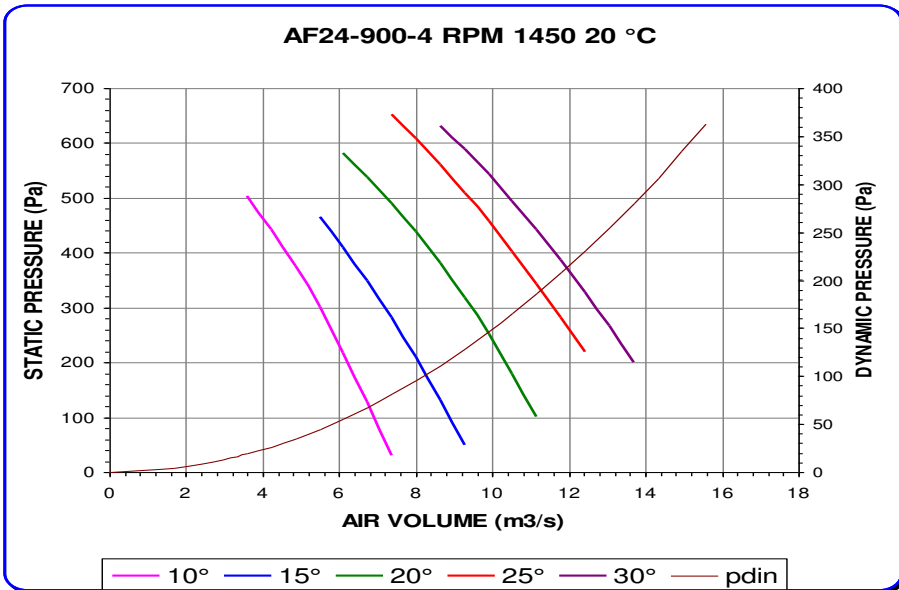
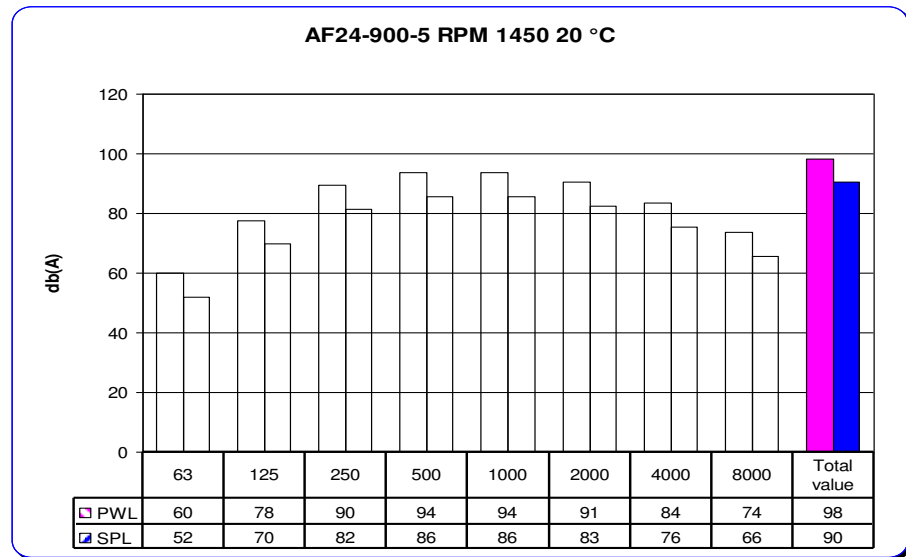
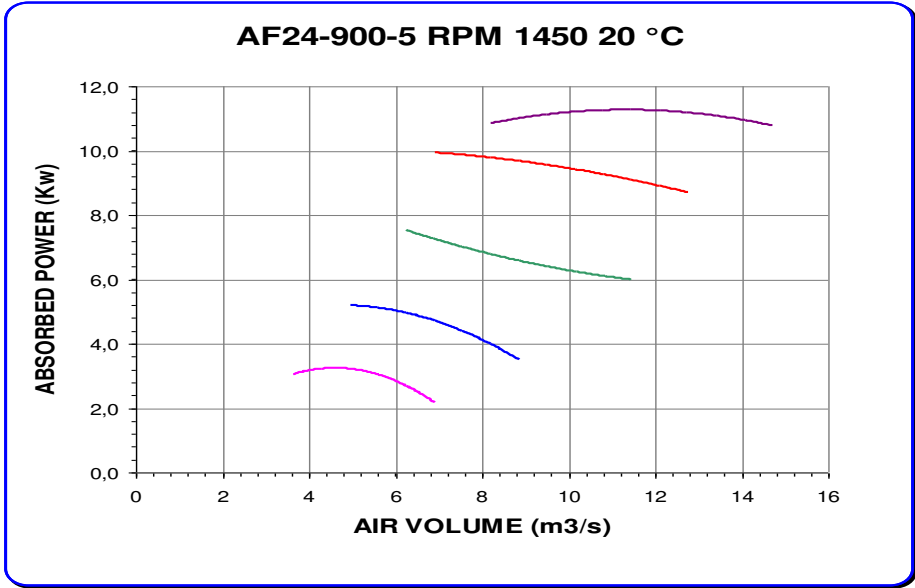
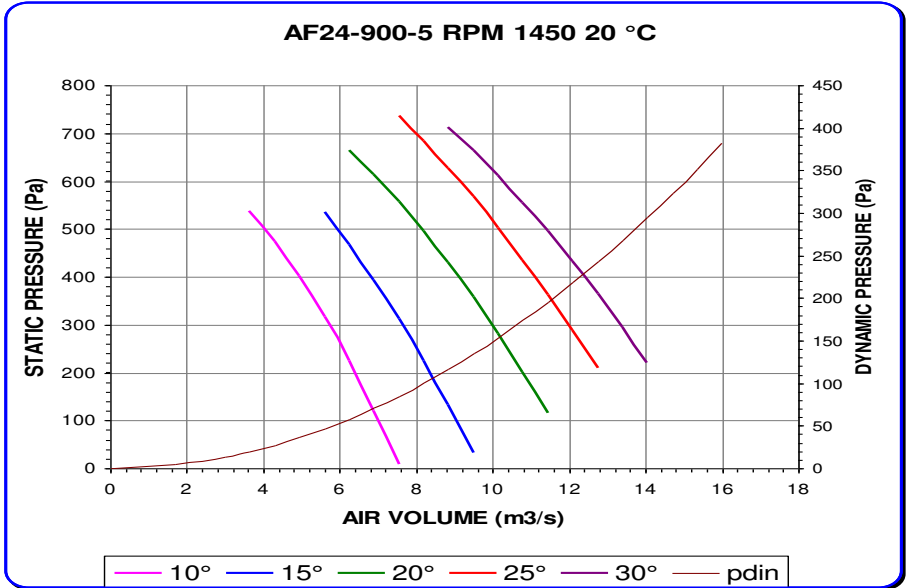

Noise spectrum referring to max efficiency of 20° curve  
 Variation of +/- 3 db(A) on total range of performance

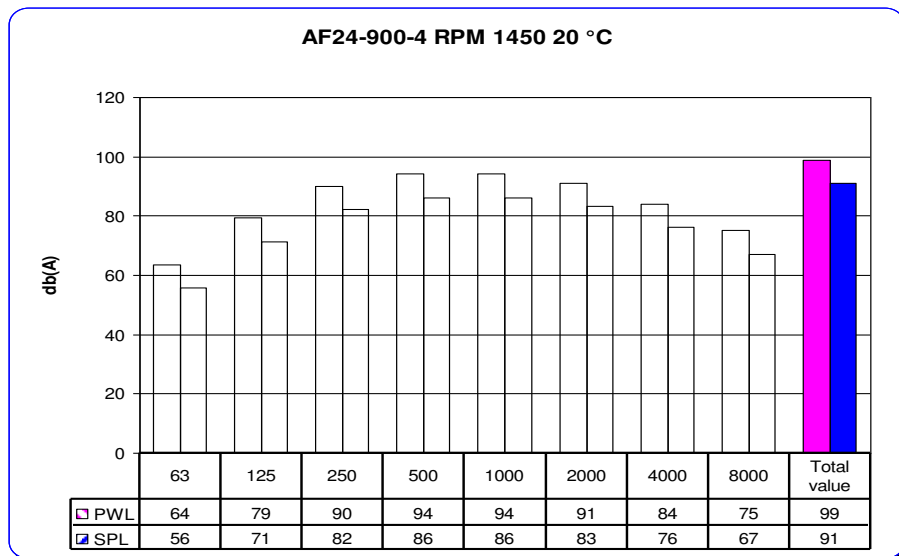
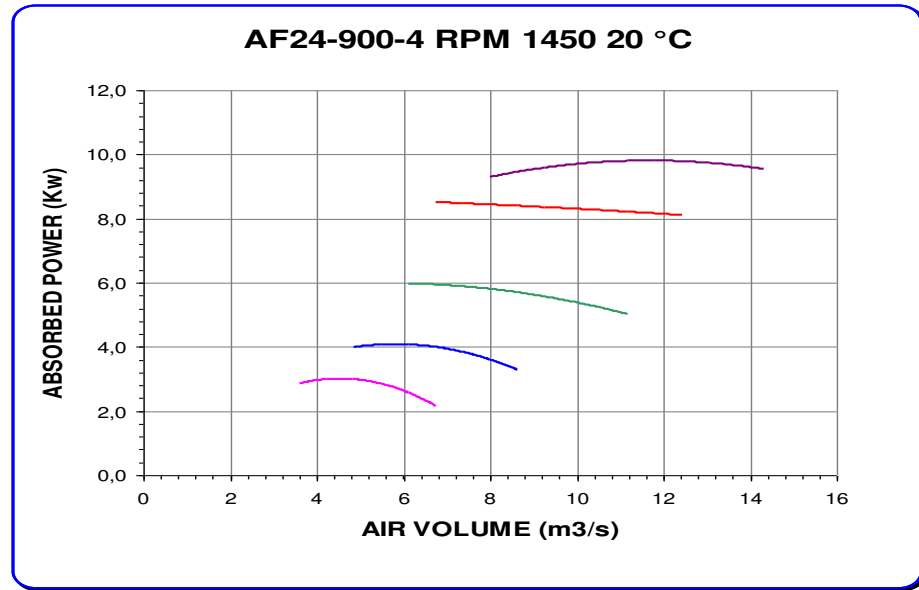
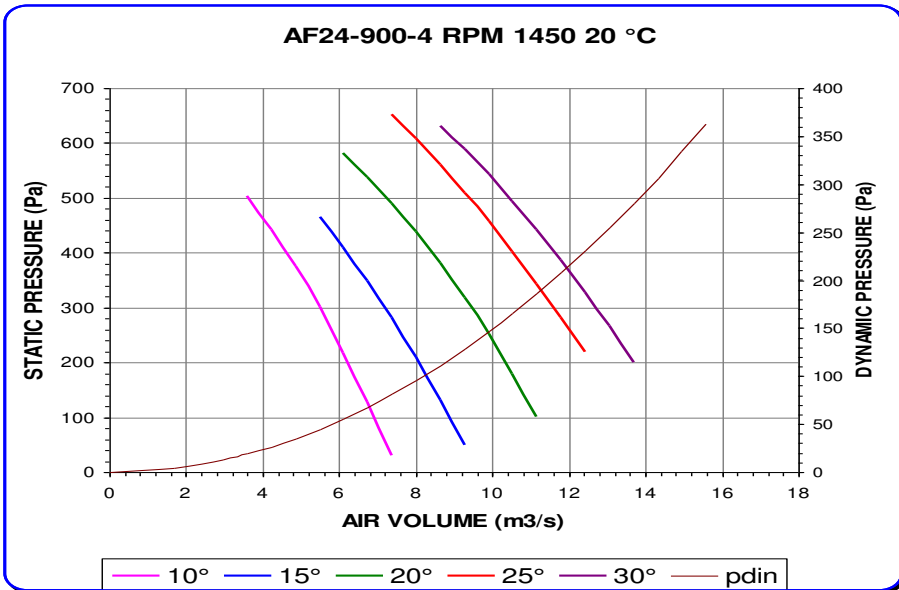

Noise spectrum referring to max efficiency of 20° curve  
 Variation of +/- 3 db(A) on total range of performance

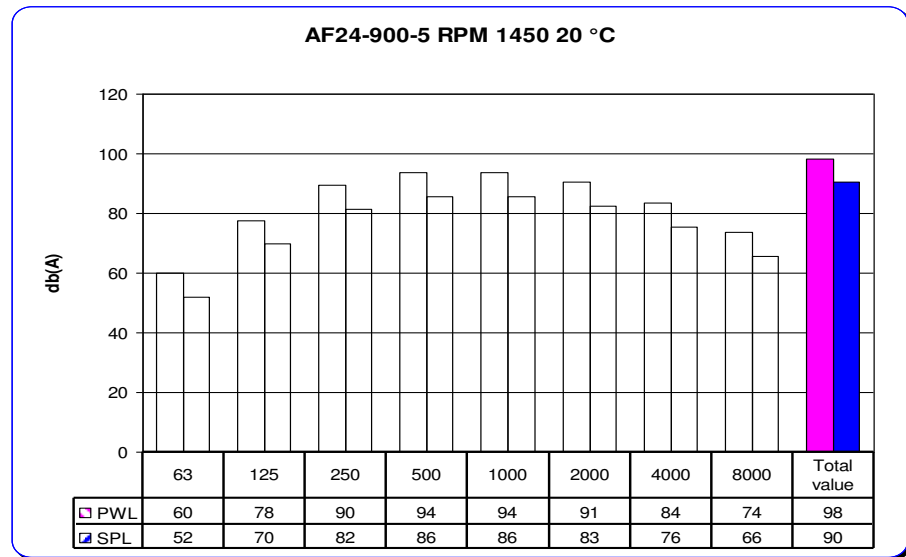
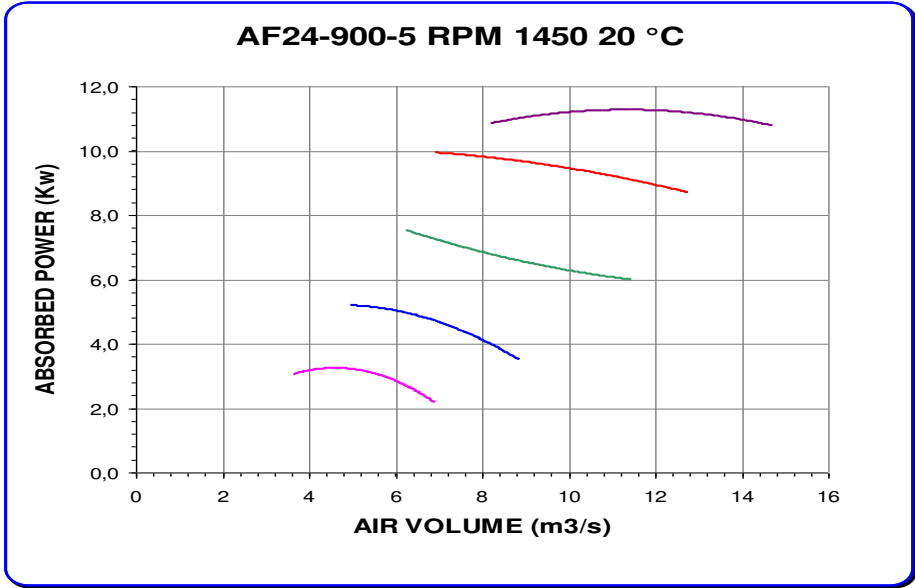
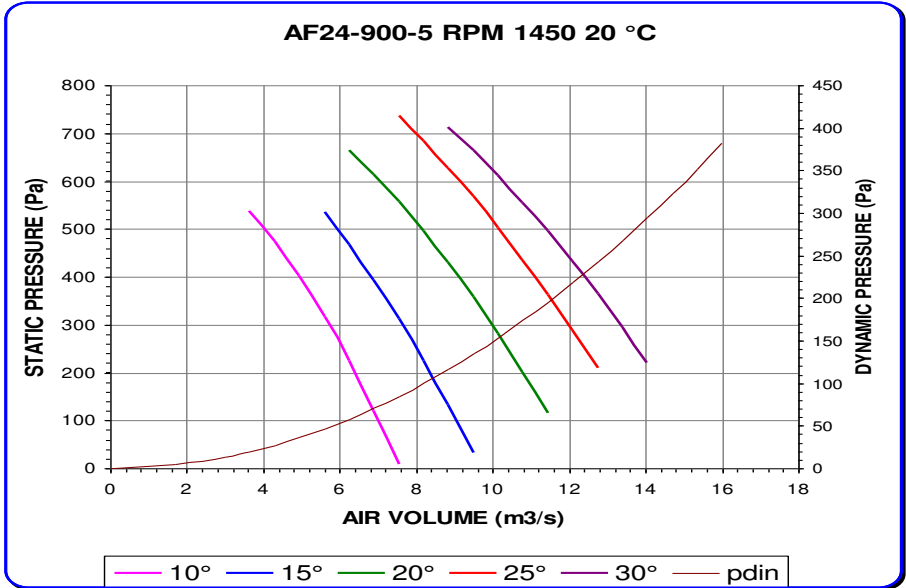

Noise spectrum referring to max efficiency of 20° curve  
 Variation of +/- 3 db(A) on total range of performance

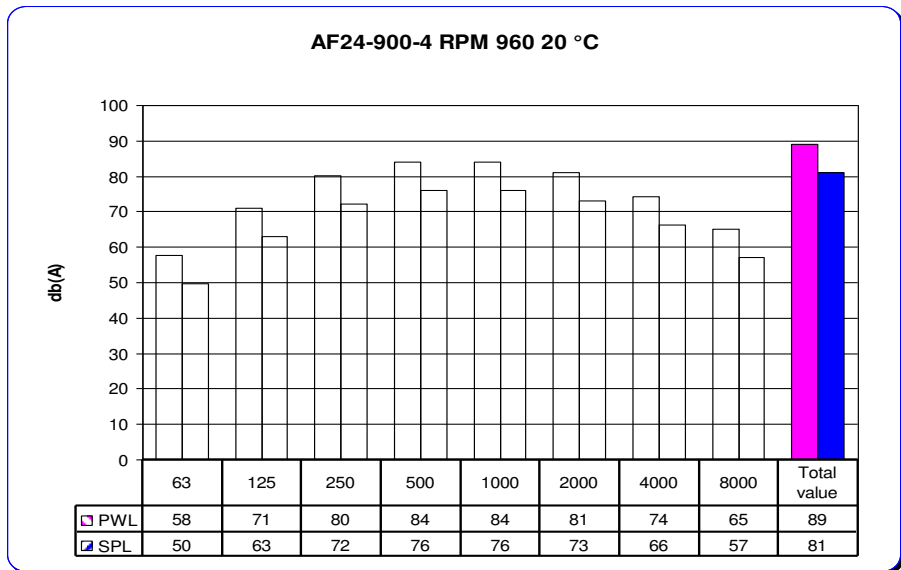
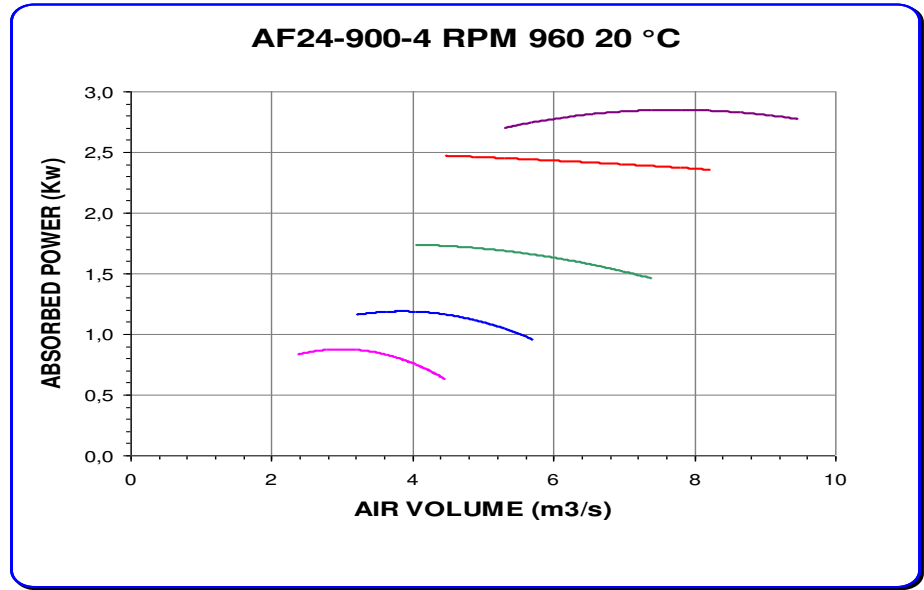
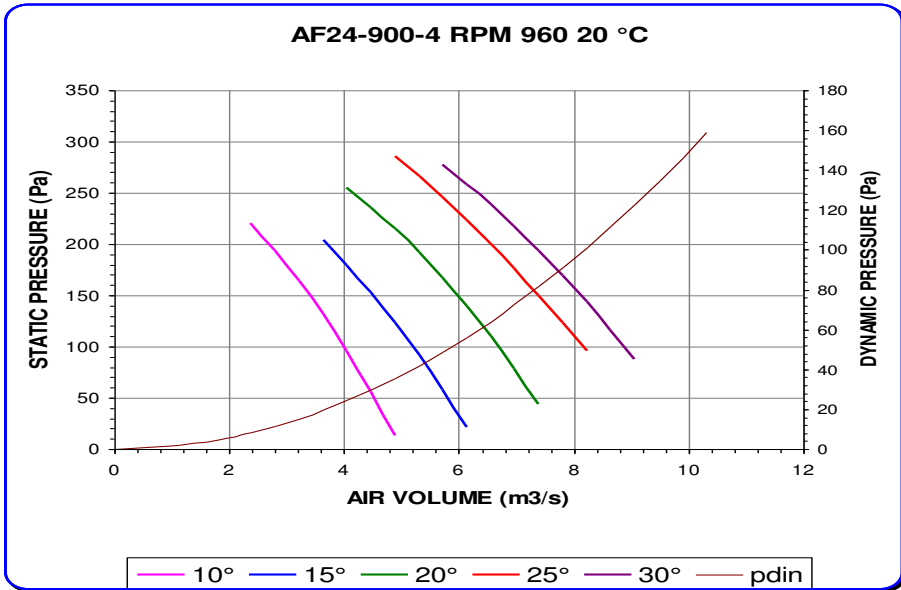

Noise spectrum referring to max efficiency of 20° curve  
 Variation of +/- 3 db(A) on total range of performance

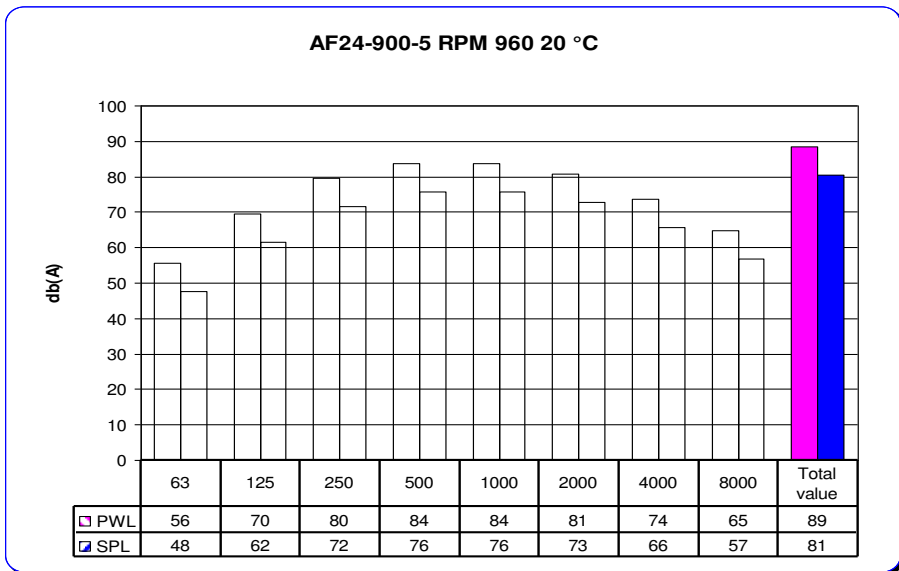
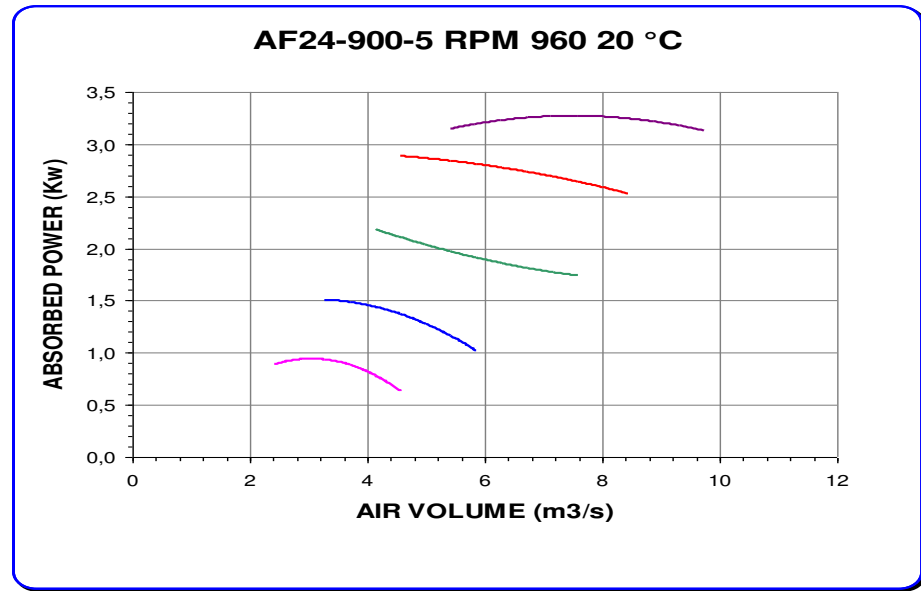
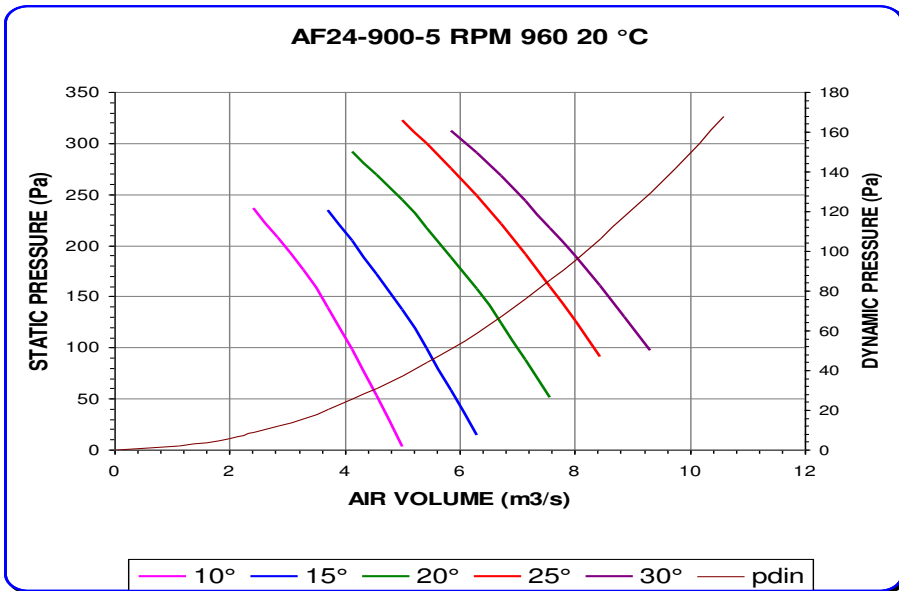

Noise spectrum referring to max efficiency of 20° curve  
 Variation of +/- 3 db(A) on total range of performance

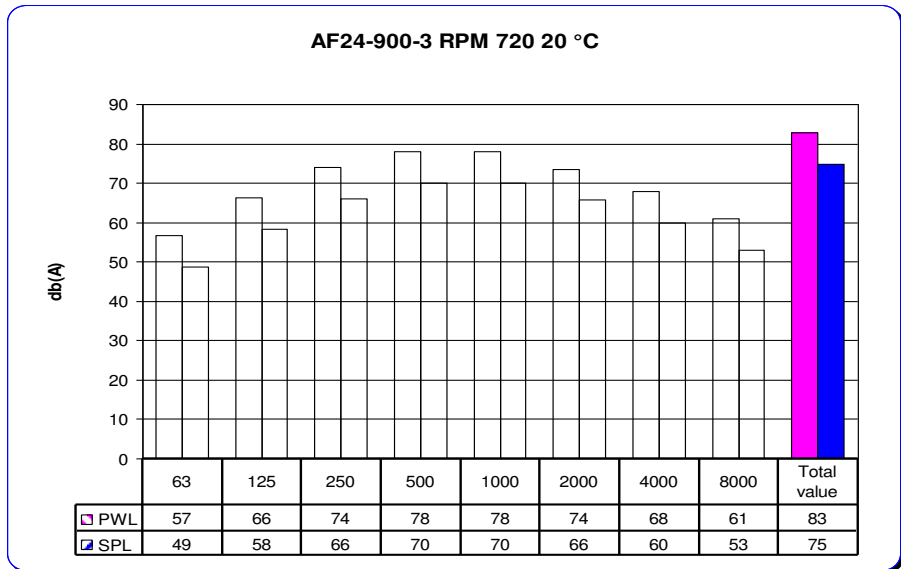
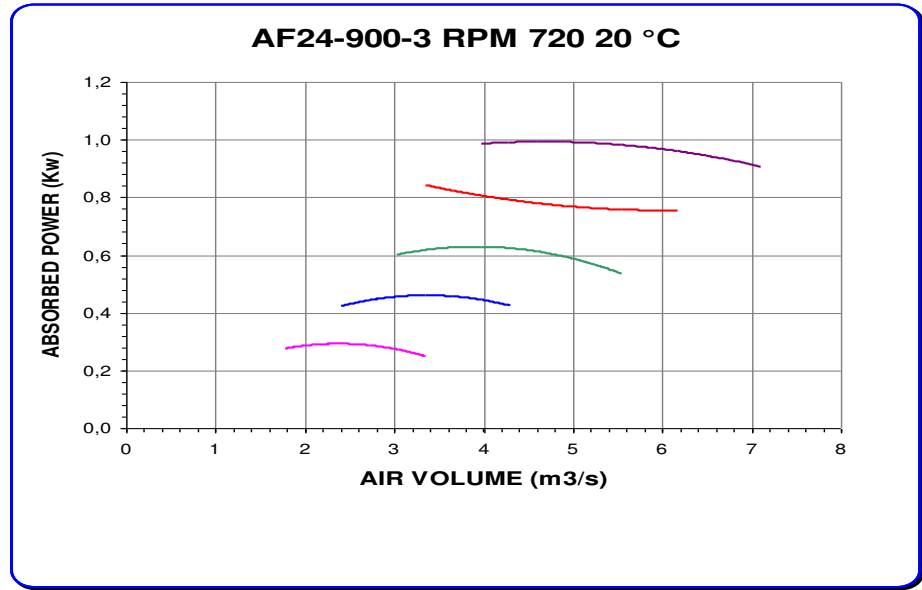
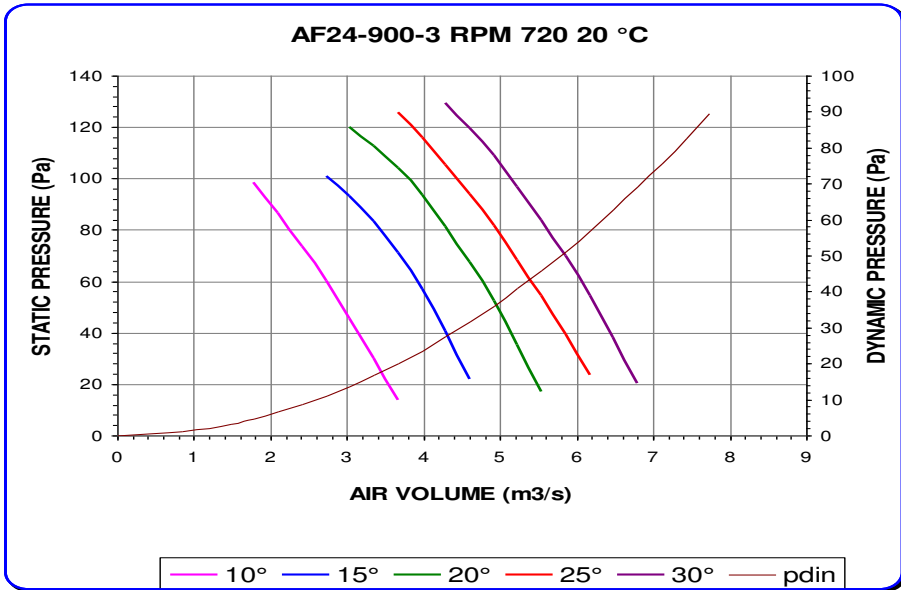

Noise spectrum referring to max efficiency of 20° curve  
 Variation of +/- 3 db(A) on total range of performance



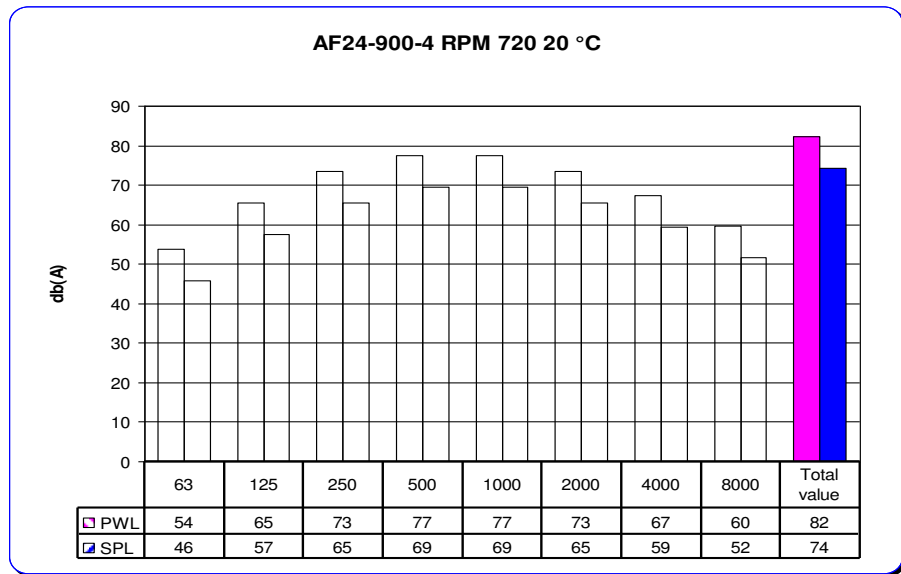
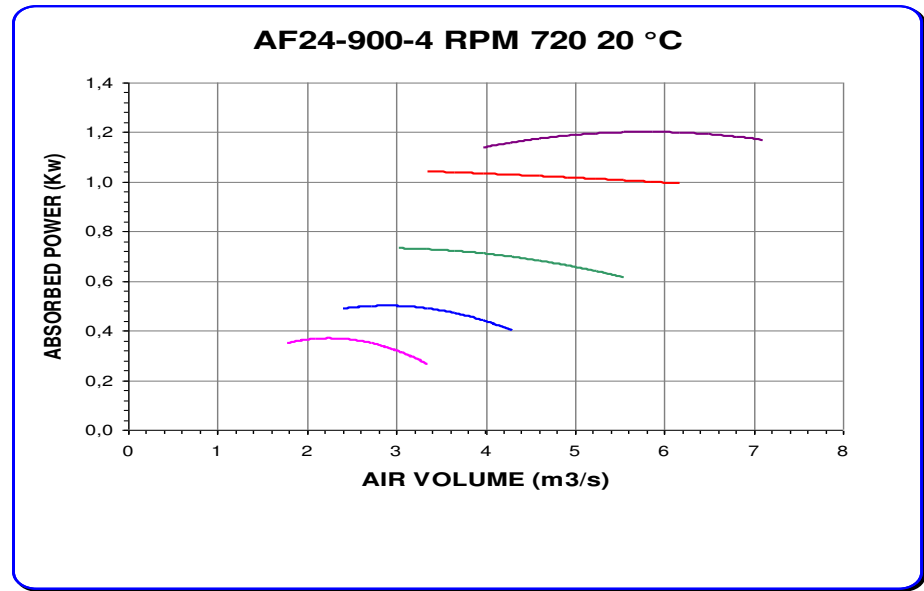
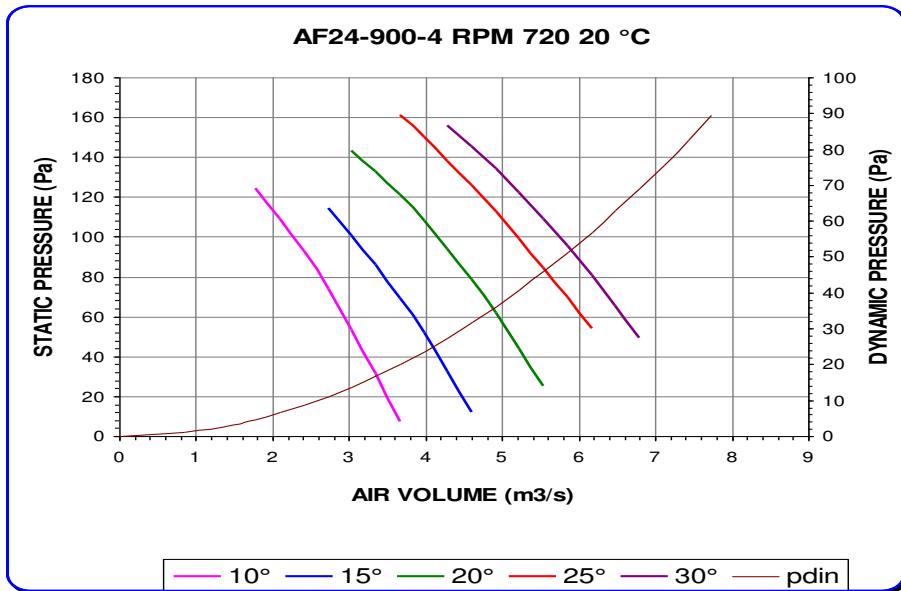

Noise spectrum referring to max efficiency of 20° curve  
 Variation of +/- 3 db(A) on total range of performance

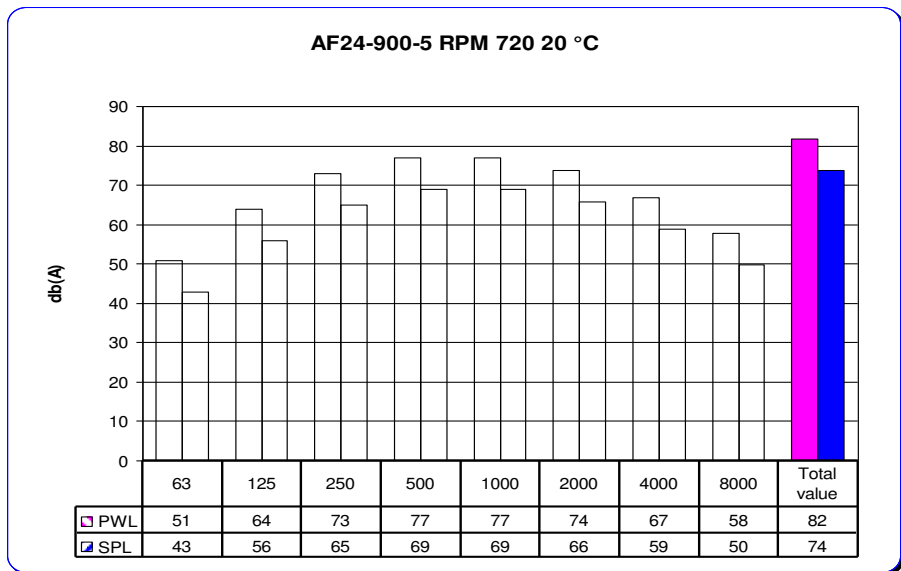
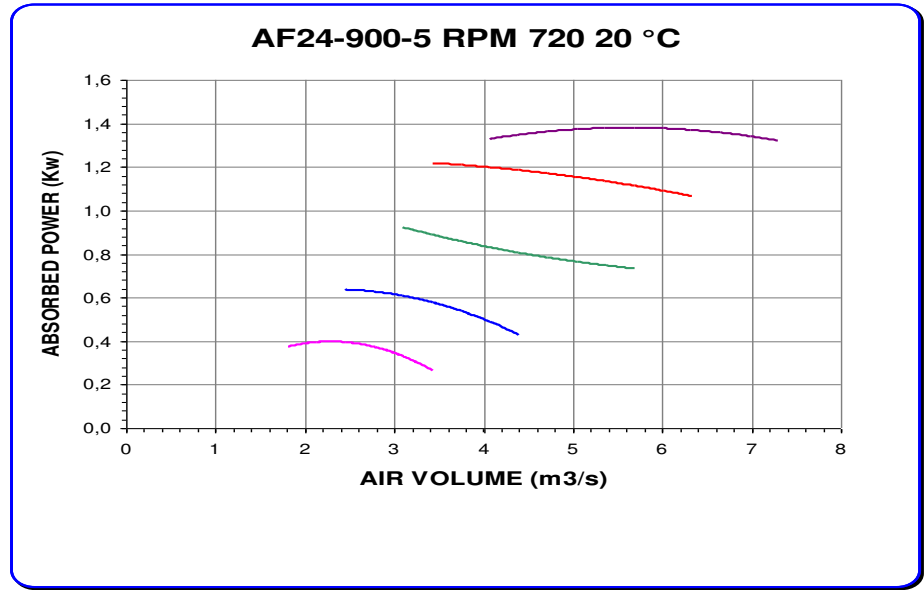
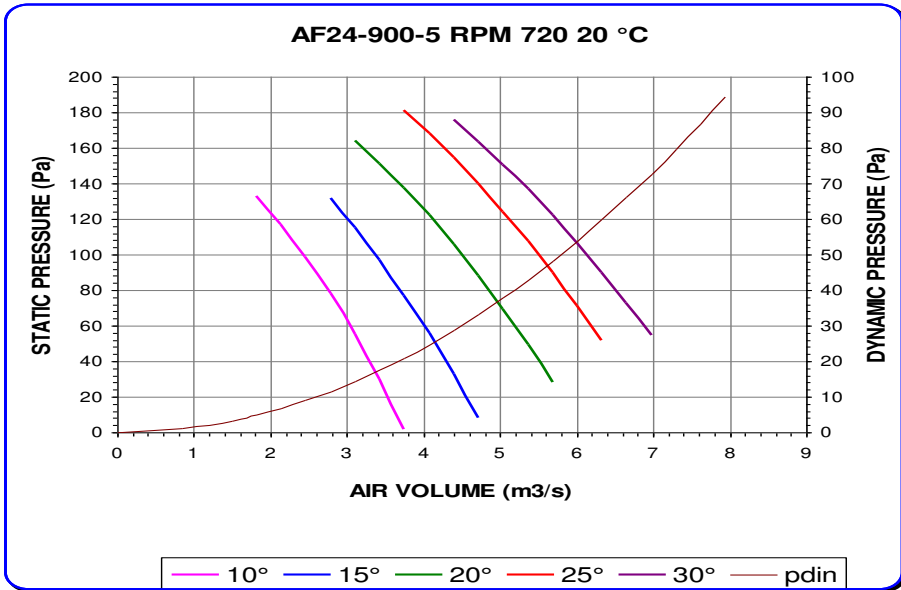

Noise spectrum referring to max efficiency of 20° curve  
 Variation of +/- 3 db(A) on total range of performance

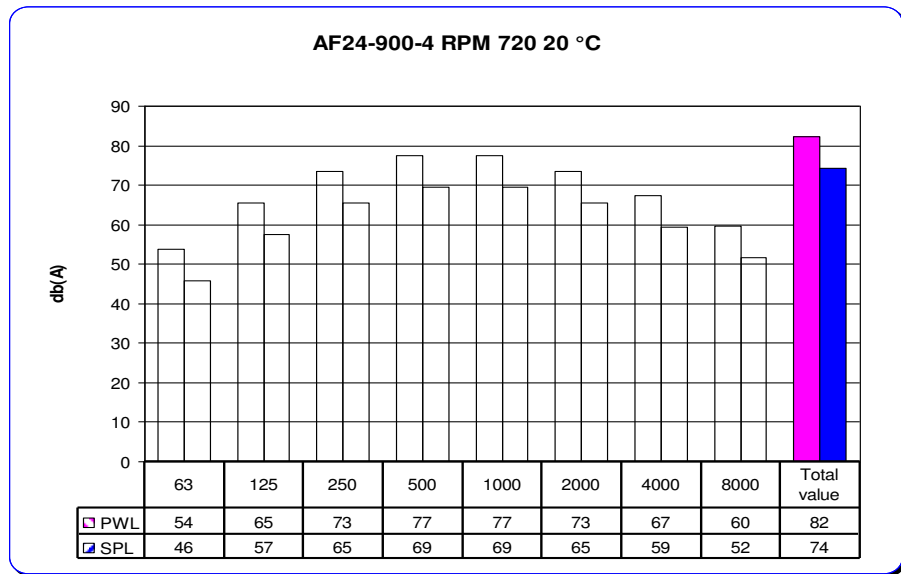
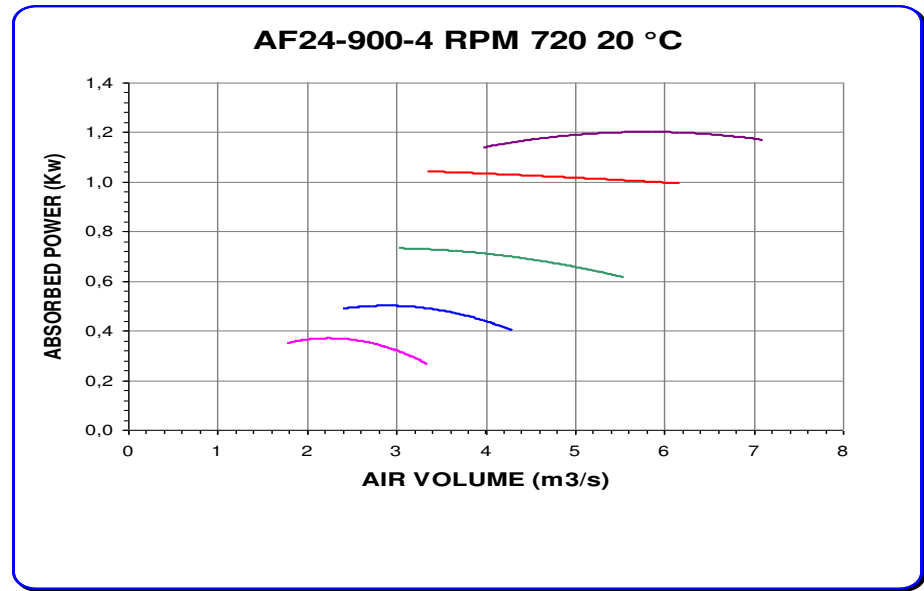
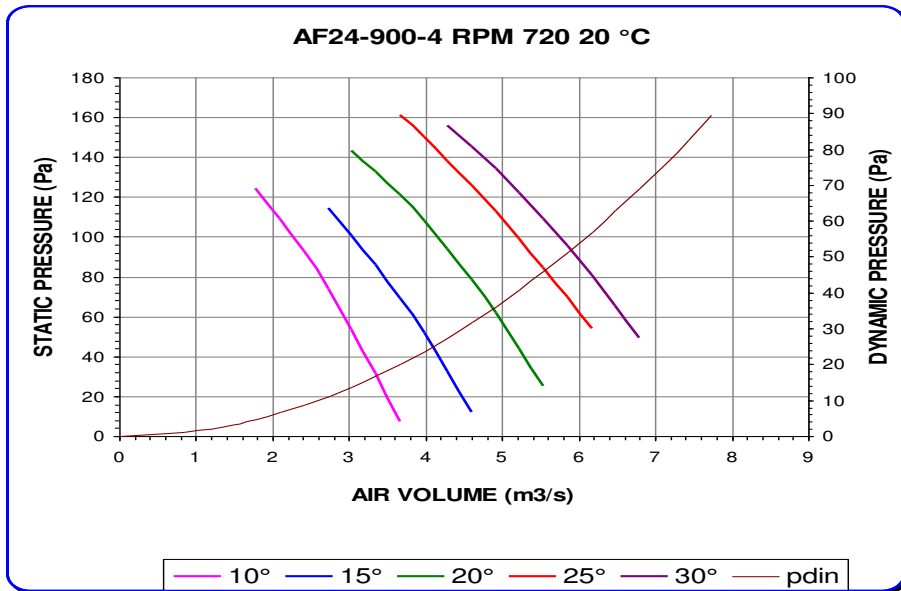

Noise spectrum referring to max efficiency of 20° curve  
 Variation of +/- 3 db(A) on total range of performance

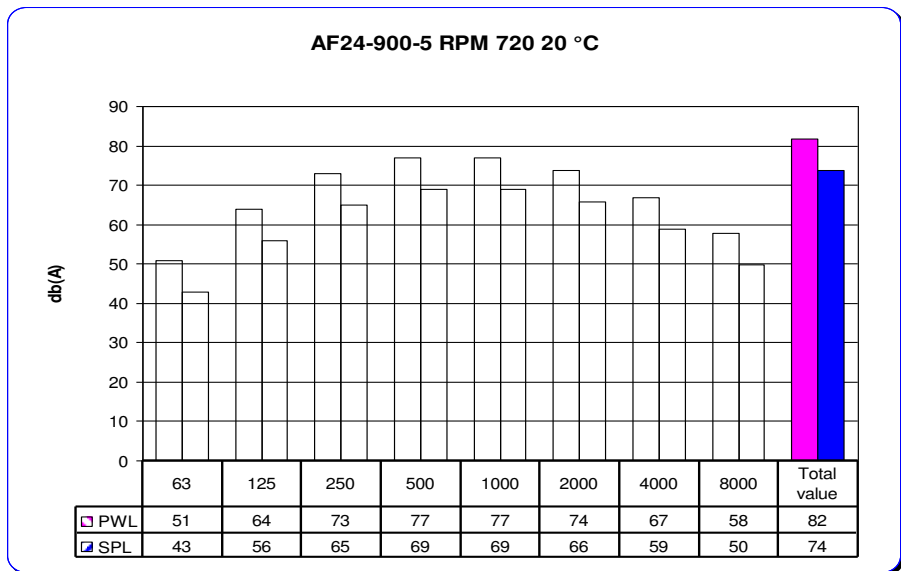
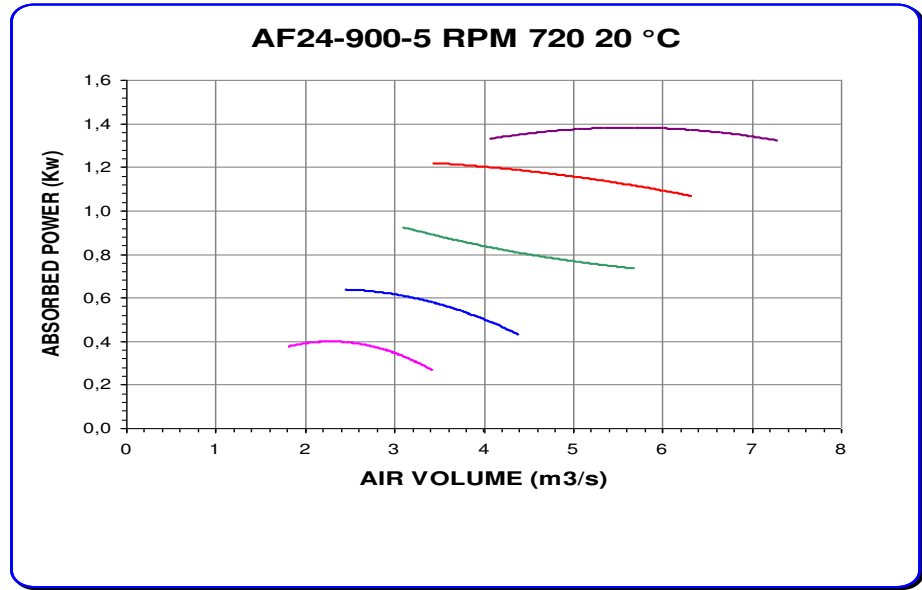
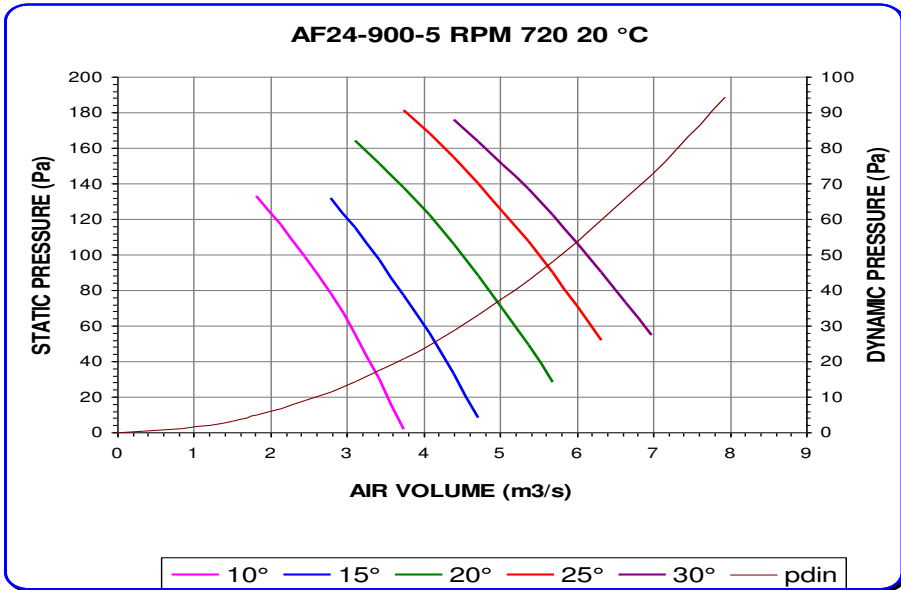

Noise spectrum referring to max efficiency of 20° curve  
 Variation of +/- 3 db(A) on total range of performance

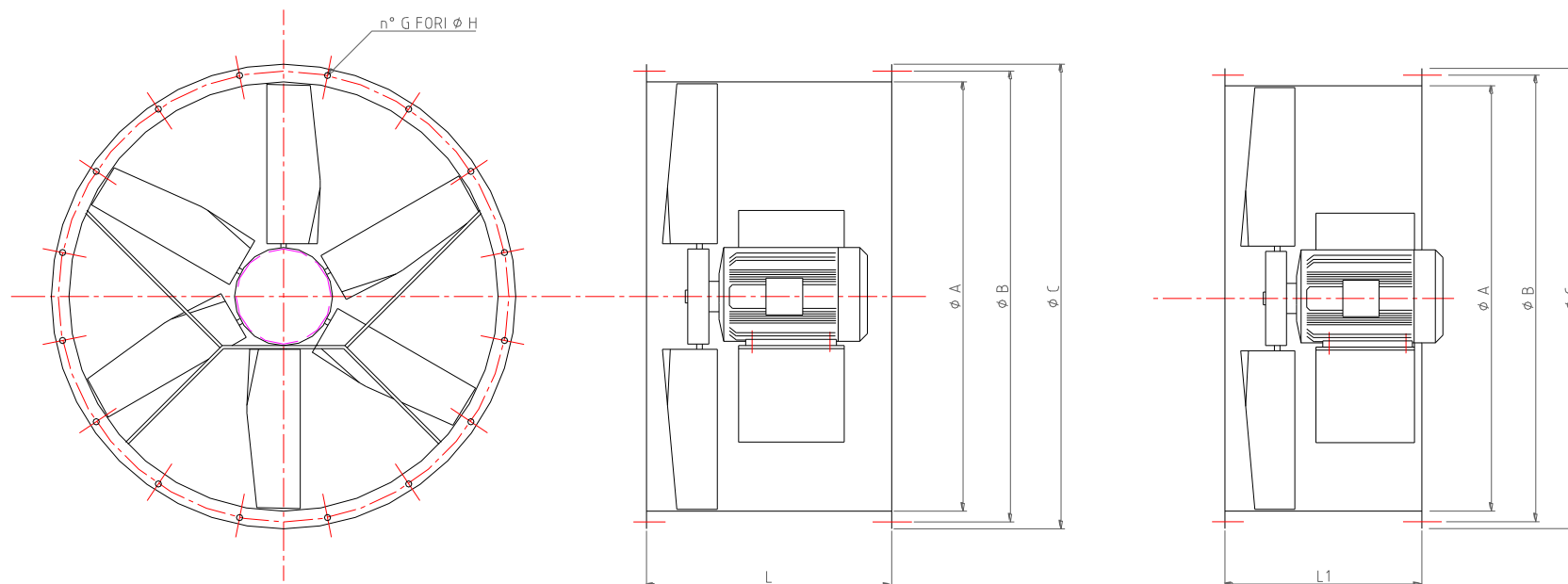

**Φ 900**

Grandezza Motore	A	B	C	L	L1	G	H	Peso medio con cassa L Kg.	Peso medio con cassa S Kg.
90								96	85
100	900	970	1005	500	350	16	12	106	95
112								114	103
132	900	970	1005	600	450	16	12	152	141
160	900	970	1005	800	600	16	12	258	213